

EMEA VERSION

POLARIS *GENERAL*

2021

ACCESSORIES + APPAREL



THE RIGHT GEAR ALWAYS MATTERS

2021 LINEUP

GENERAL

DELUXE (2 & 4 SEAT)



GENERAL 1000 DELUXE

PREMIUM PLUS:

FOX PODIUM X 2.0 QS3 SHOCKS
SPORT ROOF
STAGE 1 AUDIO SYSTEM BY ROCKFORD FOSGATE
CONVEX REAR VIEW MIRROR

Now Available in Two Color Packages

RIDE COMMAND • STAGE 4 AUDIO SYSTEM BY ROCKFORD FOSGATE UPGRADE AVAILABLE.

CONTENTS

ACCESSORIES 06

WINDSHIELDS & REAR PANELS	08
DOORS	10
ROOFS	12
VEHICLE & RIDER PROTECTION	13
STORAGE	14
CAB COMFORT	16
HUNT	18
POLARIS NORTHSTAR COOLERS	20
RIDE COMMAND & AUDIO	22
LIGHTING	24
WHEELS & TIRES	26
WINCHES	34
PLOWS & TRACKS	35

PARTS & GARAGE 36

MAINTENANCE	36
OIL & LUBRICANTS	38
SERVICE PARTS	40
HD PARTS	42
VEHICLE CARE & TRAILERING	44

APPAREL & HELMETS 46

OUTERWEAR & PROTECTION	46
LIFESTYLE APPAREL & CAPS	52
CAMO & GIFTS	54

ELEVATE YOUR ADVENTURE

OFF-ROAD'S PREMIER FAMILY OF CROSSOVER SIDE-BY-SIDES. No matter which GENERAL you choose, you begin every adventure with the best performance, the greatest utility, and the most comfortable ride you can get in a side-by-side. When you customize with Polaris Engineered Accessories you have the confidence to take on any task or any trail.

DESIGNED



Designed by the same people who designed your vehicle.

TESTED



Extensively tested in the field so you ride with 100% confidence.

TRUSTED



65 years in the business. The #1 name in Off-Road.

WE HOLD OUR PARTNERS TO THE SAME STANDARDS



WHEELS, TIRES & LIGHTING DESIGNED WITH POLARIS TO MAXIMIZE PERFORMANCE
P. 25 & 26



A GLOBAL LEADER IN AUDIO INNOVATION, DESIGN & ENGINEERING
P. 23



PRODUCTS SO GOOD THEY REPLACE OR REPAIR THEM FOR LIFE
P. 24



MAKING PRODUCTS FOR AVID SPORTSMEN SINCE 1943
P. 18

ENGINEERED TO TAKE ON **THE ELEMENTS**

TESTED & PROVEN



DUST

WIND

**BUILD YOUR CAB SYSTEM
STARTING ON P. 08**



COMFORT YOU HAVE TO EXPERIENCE TO BELIEVE

Our cab components create an experience enhancing interior, offering supreme comfort to your vehicle.



PROFILE TUBE DESIGN

Contours built into the cage deliver a premium sealing surface.



PERFECT FIT, PERFECT SEAL

A 360° gasket seal provides our tightest-sealing cab.



LOCK & RIDE EASY ON & OFF

Adapt to your needs and environment with exclusive tool-less, easy-on, easy-off Lock & Ride components.



PLUG & PLAY ELECTRICAL

EFFORTLESSLY ADD LIGHTS, HEAT, WIPERS & AUDIO.

A revolution in electrical accessory integration, the Polaris PULSE Electrical System allows for a simple plug & play approach for adding power to Polaris Engineered Accessories.

Look for  to identify Polaris PULSE ready accessories.





ELEVATE YOUR ADVENTURE



BLAZE A NEW TRAIL



PREPARE FOR THE HUNT



SPORT ESSENTIALS

LOCK & RIDE Vented Windshield - Hard Coat Poly: P. 08

Windshield Wiper & Washer System: P. 08

LOCK & RIDE Bed Extender: P. 14

Polaris Northstar 30 QT Cooler: P. 20

LOCK & RIDE Spare Tire Carrier: P. 14

Pro Armor 33" Combo LED Light Bar: P. 25

Light Bar Harness: P. 25

Rear Sport Bumper: P. 13

4-Seat Extreme Kick-Out Rock Sliders: P. 13

LOCK & RIDE Vented Windshield - Hard Coat Poly: P. 08

Sport Roof - Poly: P. 12

XL Fender Flares: P. 13 **NOT SHOWN**

LOCK & RIDE Cargo Box: P. 15

RIGID SR-Series Combo Light Bar: P. 25

Pro Armor Wheel & Tire Set: P. 33

29" Mud XC & 14" Shackle - Matte Black

Winch: P. 34

LOCK & RIDE Full Windshield - Glass: P. 08 **NOT SHOWN**

Windshield Wiper & Washer System: P. 08 **NOT SHOWN**

LOCK & RIDE Rear Panel - Glass: P. 09

Pro Armor 33" Combo LED Light Bar: P. 25 **NOT SHOWN**

Polaris Pulse LED Light Bar Harness: P. 16 **NOT SHOWN**

In addition to stock accessories

Premium Roof - Poly: P. 12

LOCK & RIDE Full Windshield - Glass: P. 08

Windshield Wiper & Washer System: P. 08

LOCK & RIDE Rear Panel - Glass: P. 09

Polaris Northstar 30 QT Cooler: P. 20

WINDSHIELDS

Keep the elements out and control air flow into the cab.

POLARIS ENGINEERED ADVANTAGES

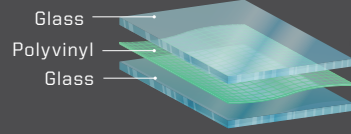

GLASS VS POLY

- Superior optical clarity [automotive level]
- Scratch resistant
- Curved to fit, seals tight
- Cold weather / heavy duty
- Wiper ready (windshield only)

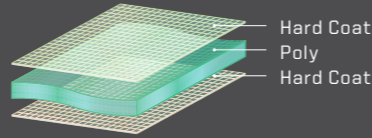

- Lightweight, flexible, easy to store/remove
- Impact-resistant
- Tight seal keeps out rain and dust
- Hard Coat: 30x more scratch resistance than regular poly windshields



LOCK & RIDE
REVOLUTIONARY INSTALLATION



AIRTIGHT GASKET SEAL

GLASS

HARD COAT POLY

POLY

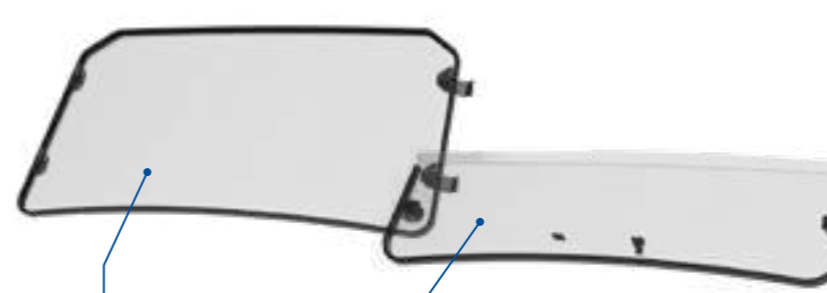
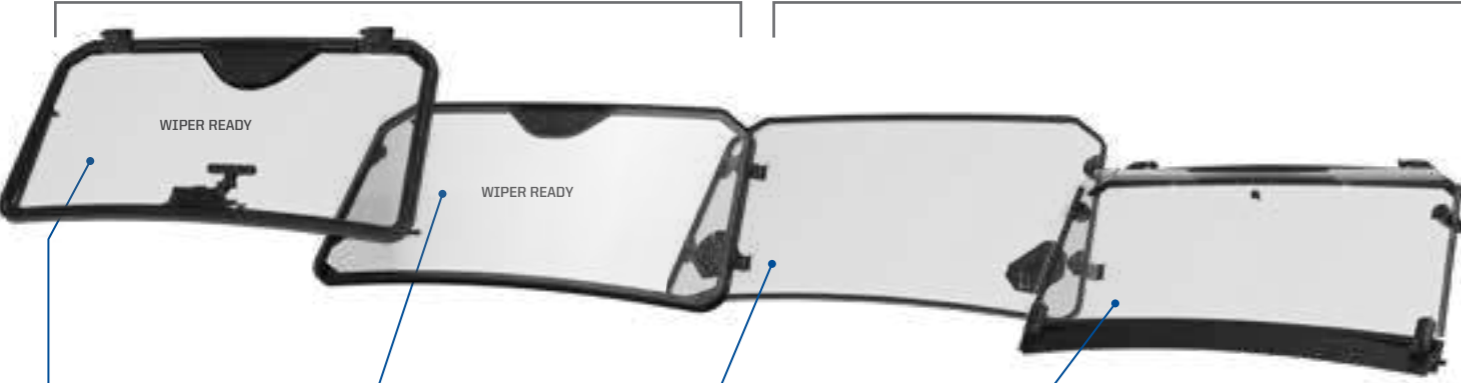

TIP-OUT WINDSHIELD - GLASS TOP SELLER
» 2881108
POLARIS GENERAL XP 1000/4 '20-21
POLARIS GENERAL 1000/4 '16-21

NEW
LOCK & RIDE
FULL WINDSHIELD - GLASS TOP SELLER
» 2889064
POLARIS GENERAL XP 1000/4 '20-21
POLARIS GENERAL 1000/4 '16-21

LOCK & RIDE
VENTED WINDSHIELD - HARD COAT POLY
» 2884223
POLARIS GENERAL XP 1000/4 '20-21
POLARIS GENERAL 1000/4 '16-21

NEW
LOCK & RIDE
FLIP-DOWN WINDSHIELD - HARD COAT POLY
» 2889156
POLARIS GENERAL XP 1000/4 '20-21
POLARIS GENERAL 1000/4 '16-21

LOCK & RIDE
FULL WINDSHIELD - HARD COAT POLY
» 2884337
POLARIS GENERAL XP 1000/4 '20-21
POLARIS GENERAL 1000/4 '16-21

LOCK & RIDE
HALF WINDSHIELD - POLY
» 2881111
POLARIS GENERAL XP 1000/4 '20-21
POLARIS GENERAL 1000/4 '16-21

WINDSHIELD WIPER & WASHER SYSTEM TOP SELLER
» 2881090
POLARIS GENERAL XP 1000/4 '20-21
POLARIS GENERAL 1000/4 '16-21



Offers fully-sealed or flipped-down venting options. Upper half detaches, leaving lower half for protection with maximum ventilation.



REAR PANELS

Turbulent air forms above the cargo bed and behind the cab when you add a windshield. This swirl can carry dirt, dust, leaves, and rain into the cab. Eliminate this phenomenon and **control the swirl** by installing a rear panel.



LOCK & RIDE
REAR PANEL - GLASS TOP SELLER
» 2881113
POLARIS GENERAL XP 1000/4 '20-21
POLARIS GENERAL 1000/4 '16-21



LOCK & RIDE
REAR PANEL - POLY
» 2881112
POLARIS GENERAL XP 1000/4 '20-21
POLARIS GENERAL 1000/4 '16-21

ADD A REAR PANEL TO REDUCE THE DUST SWIRL

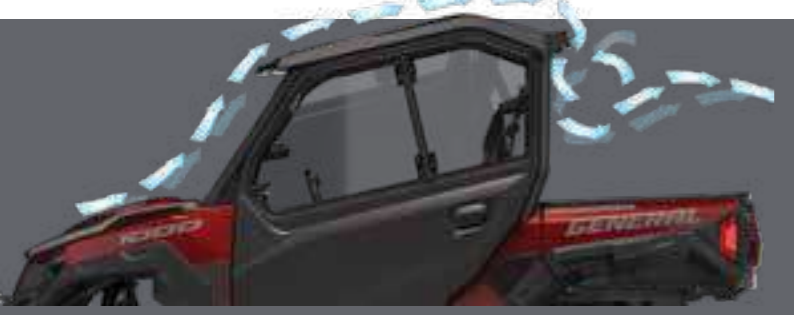

ACCESSORIES

WINDSHIELDS & REAR PANELS

DOORS

ROOFS & PROTECTION

STORAGE, CAB COMFORT & HUNT

COOLERS

RIDE COMMAND & AUDIO

LIGHTING

WHEELS & TIRES

WINDCHES & PLOWS

DOORS

COMPLETE YOUR CAB. POLARIS GENERAL comes equipped with half doors. To create an enclosed cab for increased protection from the elements, choose from two great Polaris options.



REPLACE STOCK HALF DOORS

PREMIUM POLY FULL DOORS

- Impact and scratch-resistant tempered glass
- Fully-sealed design keeps elements out for a premium in-cab environment
- Hinged window adjustability
- Soft-touch, easy-to-clean premium interior liner

2-SEAT

- Six-way glass window adjustability

» 2883717
POLARIS GENERAL XP 1000/4 '20-21
POLARIS GENERAL 1000/4 '16-21

4-SEAT

- Push-out windows
- Kit includes B-pillar cover seal

» 2883082
POLARIS GENERAL XP 4 1000 '20-21
POLARIS GENERAL 4 1000 '17-21

POLARIS ENGINEERED ADVANTAGES



PREMIUM INTERIOR HANDLE AND LINER



A PERFECT FIT FOR THE PERFECT SEAL



ADD UPPER DOORS TO STOCK HALF DOORS

ZIP WINDOW UPPER DOORS

- Durable, rugged canvas stitched over a robust steel frame
- Lightweight, UV-resistant construction
- Retention straps for increased strength
- Zipper windows for increased venting options
- Mounts easily by drilling into stock doors (drill hole plugs included)

2-SEAT

» 2882548
POLARIS GENERAL XP 1000 '20-21
POLARIS GENERAL 1000 '18-21

NOT SHOWN

4-SEAT

» 2883453
POLARIS GENERAL XP 4 1000 '20-21
POLARIS GENERAL 4 1000 '18-21

ROOFS

Protect yourself from the elements. The right roof shields you from the sun and driving rain.

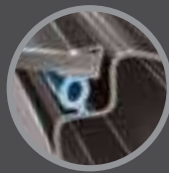

A PERFECT FIT FOR THE PERFECT SEAL

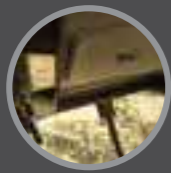

PREMIUM FEATURES & QUIETER RIDE



KEEP MOISTURE MOVING

POLARIS ENGINEERED ADVANTAGES

ALUMINUM vs POLY

- High protection strength
- Lower profile
- Sleek style
- Water run-off
- Pre-existing mounting features
- Liner ready
- Lightweight

2-SEAT

ROOF - ALUMINUM

- » 2881105
POLARIS GENERAL XP 1000 '20-21
POLARIS GENERAL 1000 '16-21



PREMIUM ROOF - POLY

- » 2883800
POLARIS GENERAL XP 1000 '20-21
POLARIS GENERAL 1000 '16-21



INCLUDES PREMIUM ROOF LINER

SPORT ROOF - POLY

- » 2883780
POLARIS GENERAL XP 1000 '20-21
POLARIS GENERAL 1000 '16-21



4-SEAT

PREMIUM ROOF - POLY

- » 2883801
POLARIS GENERAL XP 4 1000 '20-21
POLARIS GENERAL 4 1000 '17-21



INCLUDES PREMIUM ROOF LINER

TOP SELLER SPORT ROOF - POLY

- » 2883781
POLARIS GENERAL XP 4 1000 '20-21
POLARIS GENERAL 4 1000 '17-21

POLY ROOF LINER

- » 2883802
POLARIS GENERAL XP 4 1000 '20-21
POLARIS GENERAL 4 1000 '17-21
Compatible with Sport Roof - Poly (2883781), sold separately



VEHICLE & RIDER PROTECTION

Arm your POLARIS GENERAL with Polaris Engineered bumpers and guards to take on any challenge. Engineered for easy, secure installation; providing added protection for lights, bodywork and suspension.



REAR BUMPERS NOT SHOWN

SPORT

- » 2884345
POLARIS GENERAL XP 1000/4 '20-21
POLARIS GENERAL 1000/4 '16-21

HMW A-ARM GUARDS NOT SHOWN

FRONT

- » 2880274
POLARIS GENERAL XP 1000/4 '20-21
POLARIS GENERAL 1000/4 '16-21

REAR

- » 2880171
POLARIS GENERAL 1000 '16-21

FENDER FLARES

XL TOP SELLER

- » 2884220
POLARIS GENERAL 1000/4 '16-21
Not compatible with Low Profile Rock Sliders
Standard on GENERAL XP models

HIGH CLEARANCE A-ARM GUARDS

FRONT

- » 2884221
POLARIS GENERAL XP 1000/4 '20-21

REAR

- » 2884222
POLARIS GENERAL XP 1000/4 '20-21

FRONT BUMPERS

A SPORT LOW PROFILE

- » 2881094
POLARIS GENERAL XP 1000/4 '20-21
POLARIS GENERAL 1000/4 '16-21

B SPORT UPPER

- » 2881525
POLARIS GENERAL XP 1000/4 '20-21
POLARIS GENERAL 1000/4 '16-21
Requires Sport Low Profile Front Bumper

ROCK SLIDERS NOT SHOWN

LOW PROFILE

- » 2881102
POLARIS GENERAL 1000 '16-21
Not compatible with XL Fender Flares

EXTREME KICK-OUT

- » 2-SEAT • 2881101
POLARIS GENERAL XP 1000 '20-21
POLARIS GENERAL 1000 '16-21
- » 4-SEAT • 2881992
POLARIS GENERAL XP 4 1000 '20-21
POLARIS GENERAL 4 1000 '17-21

EXPANSION ANCHOR MOUNTS

TOUGH EXPANSION ANCHOR MOUNTS DESIGNED FOR POLARIS GENERAL ALLOW FOR QUICK INSTALL OF ROCK SLIDERS AND BUMPERS WITHOUT DAMAGING THE VEHICLE'S FRAME.



STORAGE

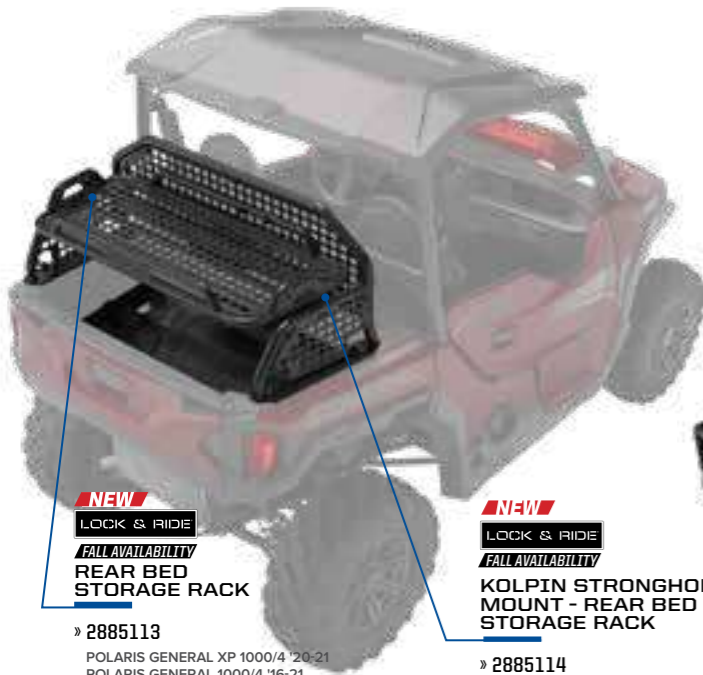

NEW
LOCK & RIDE
FALL AVAILABILITY
REAR BED
STORAGE RACK

» 2885113
POLARIS GENERAL XP 1000/4 '20-21
POLARIS GENERAL 1000/4 '16-21
See P. 18 for more info



**CARGO
BED MAT**

» 2881933
POLARIS GENERAL XP 1000/4 '20-21
POLARIS GENERAL 1000/4 '16-21

**LOCK & RIDE
TIP-DOWN
HEADACHE RACK**

» 2882144
POLARIS GENERAL XP 1000/4 '20-21
POLARIS GENERAL 1000/4 '16-21

NEW
LOCK & RIDE
FALL AVAILABILITY
KOLPIN STRONGHOLD
MOUNT - REAR BED
STORAGE RACK

» 2885114
POLARIS GENERAL XP 1000/4 '20-21
POLARIS GENERAL 1000/4 '16-21
See P. 18 for more info

**LOCK & RIDE
BED EXTENDER**

» 2881547
POLARIS GENERAL XP 1000/4 '20-21
POLARIS GENERAL 1000/4 '16-21



**LOCK & RIDE
SPARE TIRE CARRIER**

» 2881529
POLARIS GENERAL XP 1000/4 '20-21
POLARIS GENERAL 1000/4 '16-21
FITS WHEEL UP TO 30"



**BEHIND SEAT
STORAGE BAG**

» 2882164
POLARIS GENERAL XP 1000/4 '20-21
POLARIS GENERAL 1000/4 '16-21



**IN-DASH
STORAGE BAG**

» 2882165
POLARIS GENERAL XP 1000/4 '20-21
POLARIS GENERAL 1000/4 '16-21



Ample storage with
multiple openings for
ease & convenience

POLARIS ENGINEERED ADVANTAGES



LOCK & RIDE

**REVOLUTIONARY
INSTALLATION**



LOCK & RIDE

CARGO BOX

» 2881527
POLARIS GENERAL XP 1000/4 '20-21
POLARIS GENERAL 1000/4 '16-21
Includes all mounting hardware for secure installation

LOCK & RIDE

D-RINGS

» 2881545
POLARIS GENERAL XP 1000/4 '20-21
POLARIS GENERAL 1000/4 '16-21



NOT SHOWN FIRE
EXTINGUISHER HOLDER

» 2882158
POLARIS GENERAL XP 1000/4 '20-21
POLARIS GENERAL 1000/4 '16-21
Fits most 8.25 cm fire extinguishers (not included)



**EASILY
RECONFIGURE
FOR ANY TASK
OR ANY TRAIL**



ACCESSORIES

WINDSHIELDS &
REAR PANELS

DOORS

ROOFS &
PROTECTION

STORAGE, CAB
COMFORT & HUNT

COOLERS

RIDE COMMAND
& AUDIO

LIGHTING

WHEELS & TIRES

WINCHES & PLOWS

CAB COMFORT



8-VENT HEATER & DEFROST SYSTEM TOP SELLER



» 2881316

POLARIS GENERAL XP 1000/4 '20-21
POLARIS GENERAL 1000/4 '16-21

Not Compatible with Rockford Fosgate Stage 4 Audio Kits

Audio Bracket (2885112) required to install heater on vehicles with Ride Command and audio, sold separately

WINDSHIELD WIPER & WASHER SYSTEM TOP SELLER



» 2881090

POLARIS GENERAL XP 1000/4 '20-21
POLARIS GENERAL 1000/4 '16-21

*See P. 08
for windshields*



CONVEX REAR VIEW MIRROR

» 2881540

POLARIS GENERAL XP 1000/4 '20-21
POLARIS GENERAL 1000/4 '16-21



FLOOR MATS

» 2881934

POLARIS GENERAL XP 1000/4 '20-21
POLARIS GENERAL 1000/4 '16-21

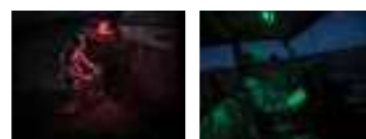

- Red light is great for reading maps
- Green light is perfect for navigating in the dark
- Blue light is ideal for night riding

MULTI-FUNCTION CAB LIGHT



- LED dome light provides white, red, green and blue lighting options
- Battery-operated, recharges when vehicle is on
- Remove to use as flashlight in and around vehicle

» 2884047

POLARIS GENERAL XP 1000/4 '20-21
POLARIS GENERAL 1000/4 '19-21

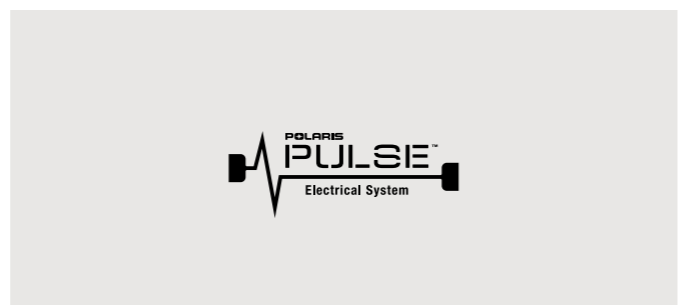

POLARIS PULSE LED LIGHT BAR HARNESS



- Required to easily add electric components

» 2883785

POLARIS GENERAL XP 1000/4 '20-21
POLARIS GENERAL 1000/4 '19-21

POLARIS ENGINEERED ADVANTAGES



ELECTRICAL INSTALLS MADE EASY WITH PLUG & PLAY

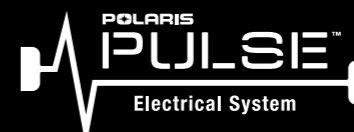

Look for to identify Polaris PULSE ready accessories.

- To install accessories, simply plug the harness into the Polaris PULSE hub
- No need to remove nuts and stack wire terminals like a three-post terminal setup
- By plugging in your accessories, a secure connection is guaranteed every time



HUNT

KOLPIN
OUTDOORS

**PROTECTING
YOUR
ESSENTIAL
GEAR SINCE
1943**



STORAGE



NEW

LOCK & RIDE FALL AVAILABILITY
**REAR BED
STORAGE RACK**

- Take more gear with 2 Kolpin Stronghold XL mounts and integrated MOLLE panels
- 30 or 60 Qt. Polaris Coolers will still fit in bed with rack installed

» 2885113

POLARIS GENERAL XP 1000/4 '20-21
POLARIS GENERAL 1000/4 '16-21

NEW

LOCK & RIDE FALL AVAILABILITY
**KOLPIN STRONGHOLD MOUNT
- REAR BED STORAGE RACK**

- Kolpin Stronghold mount for attaching gun boots or other Kolpin Stronghold items to a General Rear Rack

» 2885114

POLARIS GENERAL XP 1000/4 '20-21
POLARIS GENERAL 1000/4 '16-21

KOLPIN STRONGHOLD CASES

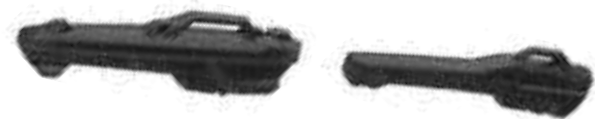

**KOLPIN
STRONGHOLD GUN BOOTS**

» XL TRANSPORT • 2882430*

POLARIS GENERAL XP 1000/4 '20-21
POLARIS GENERAL 1000/4 '16-21

» L IMPACT • 2882426*

POLARIS GENERAL XP 1000/4 '20-21
POLARIS GENERAL 1000/4 '16-21



**KOLPIN STRONGHOLD
AUTO-LATCH MOUNT**

» 2884106

POLARIS GENERAL XP 1000/4 '20-21
POLARIS GENERAL 1000/4 '16-21



**KOLPIN STRONGHOLD POP-UP
BLIND/ICE AUGER BOOT**

» 2882427*

POLARIS GENERAL XP 1000/4 '20-21
POLARIS GENERAL 1000/4 '16-21

KOLPIN RHINO GRIPS

IDEAL FOR BOWS & UNCASSED GUNS

LOCK & RIDE
RHINO GRIP PRO

» 2884107

POLARIS GENERAL XP 1000/4 '20-21
POLARIS GENERAL 1000/4 '16-21

LOCK & RIDE
**RATCHETING
RHINO GRIP**

» 2881575

POLARIS GENERAL XP 1000/4 '20-21
POLARIS GENERAL 1000/4 '16-21

LOCK & RIDE
RHINO GRIP XLR

» 2881574 • SINGLE

POLARIS GENERAL XP 1000/4 '20-21
POLARIS GENERAL 1000/4 '16-21

LOCK & RIDE
**RHINO GRIP
XLR - DOUBLES**

» 2884108

POLARIS GENERAL XP 1000/4 '20-21
POLARIS GENERAL 1000/4 '16-21

NEW
**HEAVY-DUTY XLR
REPLACEMENT
RUBBER STRAPS (2)**

» 2889204

POLARIS GENERAL XP 1000/4 '20-21
POLARIS GENERAL 1000/4 '16-21

**RHINO GRIP PRO
RUBBER STRAPS**

» 2884109

POLARIS GENERAL XP 1000/4 '20-21
POLARIS GENERAL 1000/4 '16-21

**KEEP IT
ICE COLD**



**GRIZZLY TESTED.
POLARIS APPROVED.**



This cooler is IGBC-approved, meaning it withstands the power expended by a typical grizzly bear if it was trying to get inside.

Seriously, there are experts who know what a grizzly is capable of doing, and they certify our coolers can take it.



**28, 57 & 99
LITER FEATURES**



ComfortCarry Handles



TravelLock System



EasyOut Drain System



NoSlip Rubber Feet



PolarWall Insulation



IceLock Seal

POLARIS NORTHSTAR COOLERS CAN SURVIVE JUST ABOUT ANYTHING - FROM EXTREME HEAT TO A NASTY TUMBLE OFF A VEHICLE.



99 LITER

- » GRAPHITE • 2883426
- » DESERT • 2883392



57 LITER

- » GRAPHITE • 2883425
- » DESERT • 2881259



28 LITER

- » GRAPHITE • 2883424
- » DESERT • 2881315



14 LITER









- » GRAPHITE • 2883968

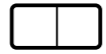

19 LITER SOFTSIDE

- » GRAPHITE • 2883390

ESSENTIAL ACCESSORIES SO YOUR COOLER WORKS AS HARD AS YOU DO

COOLER ACCESSORIES	99 LITER	57 LITER	28 LITER	DON'T FORGET THESE ACCESSORIES		
 <p>WIRE BASKET</p>	2883648	2882185	2882438	 <p>TUMBLERS</p> <ul style="list-style-type: none"> » 887 mL • 2883394 » 591 mL • 2883393 	 <p>LOCK & RIDE QUICKSTRAP</p> <ul style="list-style-type: none"> » 2882187 <p>ALL COOLERS AND POLARIS GENERAL CARGO BOXES</p>	 <p>BOTTLE OPENER</p> <ul style="list-style-type: none"> » 2882183 <p>ALL COOLERS</p>
 <p>DIVIDERS Doubles as cutting board</p>	2883468 COMES WITH ONE DIVIDER  1 way to partition	2882184 COMES WITH TWO DIVIDERS  2 ways to partition	2882186 COMES WITH ONE DIVIDER  1 way to partition			
 <p>SEAT CUSHION</p>	NOT AVAILABLE	2882179	2882507			
 <p>WHEELS</p>	2883967	2882180	NOT AVAILABLE			

RIDECOMMAND

- **BUILT-IN GPS WITH TOPOGRAPHY MAPS TO SEE YOUR LOCATION AND PLAN YOUR RIDE**
- **MEDIA PLAYER WITH BUILT IN AM/FM TUNER FOR ALL YOUR FAVORITE MUSIC**
- **GROUP RIDE FOR BUDDY TRACKING, TO SEE YOUR FRIENDS ON THE MAP, TRACK AND SHARE RIDE STATS ON THE DISPLAY OR RIDE COMMAND MOBILE APP**

REVOLUTIONIZING THE OFF-ROAD EXPERIENCE

RIDE COMMAND 7" DISPLAY

- 7" High Bright Touchscreen visible in all conditions
- Displays critical vehicle information for fuel level, coolant temp and battery voltage
- Media player with built in AM/FM tuner*
- Enhanced Group Ride capability to track and share your ride
- Dedicated shortcut buttons for quick access to features
- Bluetooth and USB smart phone connectivity
- Front camera support for better visibility on and off trail

» 2884072
POLARIS GENERAL XP 1000/4 '20-21
POLARIS GENERAL 1000/4 '19-21

RIDE COMMAND MOUNT KIT

- Mount Ride Command seamlessly into the dash for perfect fit and finish
- Comes with wiring harnesses needed and accessory components
- Includes front and rear camera, V2V, and GPS antenna

» 2884283
POLARIS GENERAL XP 1000/4 '20-21
POLARIS GENERAL 1000/4 '20-21

NEW AUDIO BRACKET

- Used to mount audio amplifier for front and rear speakers when subwoofer is removed
- Required to install a heater on a vehicle with Ride Command and audio

» 2885112
POLARIS GENERAL XP 1000/4 '20-21
POLARIS GENERAL 1000/4 '20-21

DOWNLOAD THE RIDE COMMAND MOBILE APP



AUDIO



- PLUG AND PLAY
- ELEMENT READY
- NO LOSS OF CARGO SPACE
- BLUETOOTH CAPABLE

An industry first. A true factory installed integrated off-road audio system. Rockford Fosgate partnered with Polaris to purpose build the highest performing system specifically for the GENERAL platform. Tuned and rider-centric to create a class leading audio experience that is second to none.



STAGE 1 AUDIO KIT

- PMX-P2 HEAD UNIT & FRONT COAXIAL SPEAKERS
 - 16.51 cm 6.86 cm full color display with AM/FM/WB tuner*, Pandora Control and Bluetooth Connectivity
 - 50 Watt 16.51 cm front coaxial speakers with enclosures and grilles
- » 2884282
POLARIS GENERAL XP 1000/4 '20-21
POLARIS GENERAL 1000/4 '20-21



NEW STAGE 2 PMX AUDIO KIT + REAR SPEAKERS

- REAR COAXIAL SPEAKERS & AMP
 - 2, 50 Watt 16.51 cm rear coaxial speakers with enclosures and grilles
 - 400 Watt 4-channel full range amplifier
 - IP67 Rating delivering water resistance and dust protection
- » 2885162
POLARIS GENERAL XP 1000/4 '20-21
POLARIS GENERAL 1000/4 '16-21



NEW STAGE 2 RIDE COMMAND AUDIO KIT + REAR SPEAKERS

- FRONT & REAR COAXIAL SPEAKERS & AMP
 - 2, 50 Watt 16.51 cm front and rear coaxial speakers with enclosures and grilles
 - 400 Watt 4-channel full range amplifier
 - IP67 Rating delivering water resistance and dust protection
- » 2885163
POLARIS GENERAL XP 1000/4 '20-21
POLARIS GENERAL 1000/4 '16-21
REQUIRES RIDE COMMAND 7" DISPLAY 2884072 & MOUNT KIT 2884283 (BOTH SOLD SEPARATELY)



NEW STAGE 4 UPGRADE

- SUBWOOFER
 - Compatible with Stage 1 and Stage 2 PMX-P2 Audio Kits
 - 200 Watt 16.51 cm subwoofer
- » 2889053
POLARIS GENERAL XP 1000/4 '20-21
POLARIS GENERAL 1000/4 '16-21

BUILD YOUR SOUND

HEAD UNIT:	PMX-P2		RIDE COMMAND
AUDIO:	STAGE 1 AUDIO KIT	STAGE 2 + 4 UPGRADES	STAGE 4 RIDE COMMAND AUDIO KIT
MODEL FITMENT:	<p>XP</p> <p>DELUXE</p> <p>PREMIUM</p> <p>SPORT</p>	<p>FACTORY INSTALLED STOCK AUDIO</p> <p>STAGE 1 AUDIO KIT WITH PMX-P2 HEAD UNIT</p> <p>NEW STAGE 2 + REAR SPEAKERS UPGRADE REAR SPEAKERS, AMP + AUDIO BRACKET 2885162</p> <p>+ OPTIONAL SUBWOOFER</p> <p>NEW STAGE 4 UPGRADE SUBWOOFER 2889053 NOT COMPATIBLE WITH 8-VENT HEATER & DEFROST SYSTEM (2881316)</p>	<p>RIDE COMMAND + STAGE 4 AUDIO SYSTEM UPGRADE PACKAGE INSTALLED</p> <p>TO ADD 8-VENT HEATER & DEFROST SYSTEM (2881316), SUBWOOFER MUST BE REMOVED AND AMP RELOCATION BRACKET (2885112) MUST BE INSTALLED</p> <p>RIDE COMMAND 2884072</p> <p>+ MOUNT KIT 2884283 2020-2021 MODELS</p> <p>+ STAGE 2 UPGRADE REAR SPEAKERS, AMP + AUDIO BRACKET 2885163</p> <p>+ STAGE 4 UPGRADE SUBWOOFER 2889053</p> <p>NOT COMPATIBLE WITH 8-VENT HEATER & DEFROST SYSTEM (2881316)</p>

*The FM Frequency range is from 88 to 108 and only on the odds (i.e. 88.1, 88.3, etc).



POLARIS ENGINEERED ADVANTAGES

MOUNTS PERFECTLY
Designed for your Polaris Engineered bumper, roof or other mounting point

MAX PERFORMANCE
Validated to work as hard as your machine does

DOESN'T OVERTAX
Trust it to work when you need it to

PRO ARMOR



ADVANCED TECH

RIGID lights are driven by Aluminum PCB Smart Boards, 6063-T5 aircraft aluminum extruded housings and Tiger Drylac UV protection polyester powdercoating.

EXCLUSIVE OPTICS

RIGID invests heavily in optical science and has patented multiple optics and optics systems, maximizing light output and efficiency.

RUGGED CONSTRUCTION

Pro Armor lights are designed to be big and beefy with an aggressive style all their own, and housed in IP67 marine-grade rated UV polyester powdercoating.

MASSIVELY BRIGHT

Pro Armor builds bright lights designed for any riding experience. All that power is directed through heat dissipating aluminum for streamlined heat management.

LIGHT BAR TYPES



SR-SERIES PRO

Sleek, powerful, low-profile (under 5 cm tall). Lights extreme distances with low energy usage. Available in 25.4 cm & 81.3 cm



D-SERIES PRO

Compact to fit almost anywhere with high output and low energy usage. Available in Driving, Flood & Spot



DUAL-ROW LED LIGHT BARS

The most spread and farthest illumination downrange. Easy to mount. Available in Cube, 25.4 cm, 50.8 cm & 76.2 cm



SINGLE-ROW LED LIGHT BARS

Powerful, compact, low-profile light bars with sleek look. Available in 27.9 cm, 83.8 cm & 101.6 cm



CUBE LED LIGHTS

Small size allows mounting in strategic locations for added lighting. Available in Flood & Spot

LIGHT BAR OPTIONS

OPTICS DRIVING FLOOD

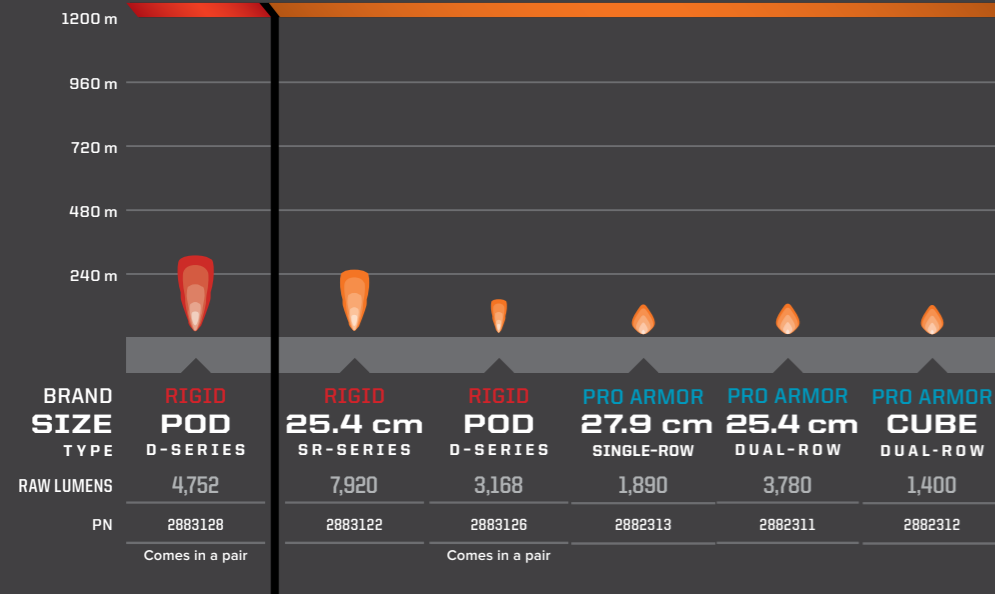

SPOT

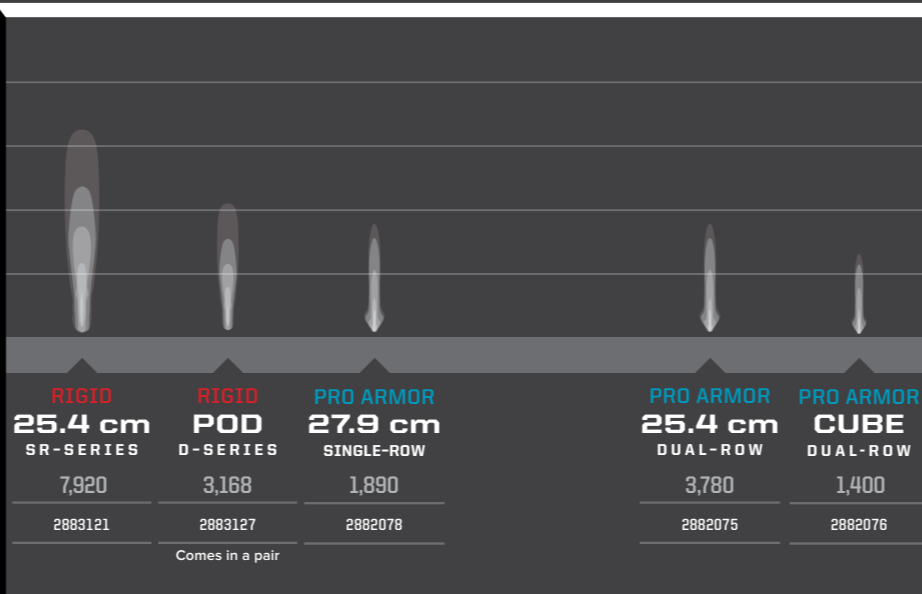

COMBO

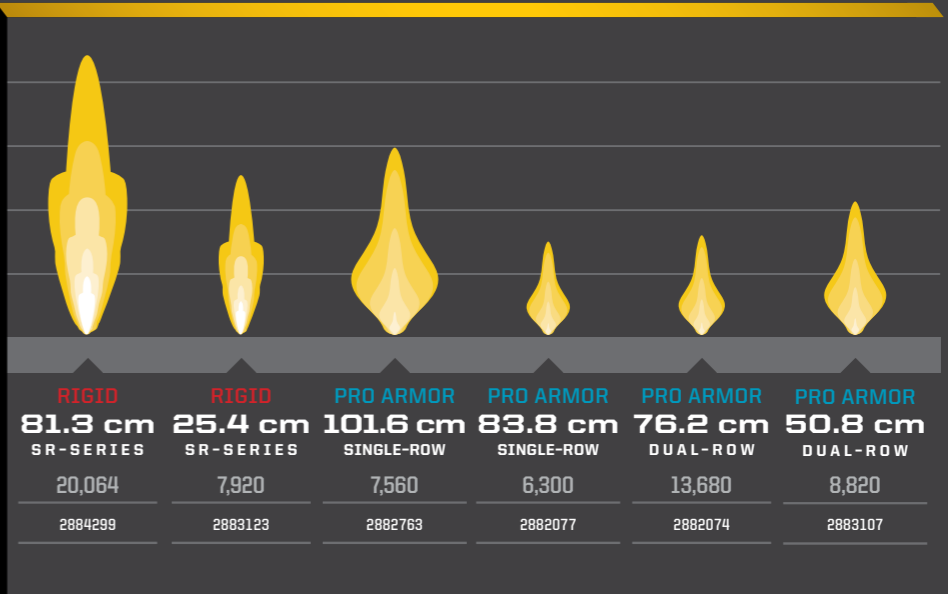

OPTICS

BUILD YOUR VISION

Consider the Optics, Angle & how you will use your vehicle to choose the right light or set of lights.

OPTICS LIGHT ANGLE	ACCENT	DRIVING (45°)	FLOOD (25°)	SPOT (10°)	COMBO (25°/10°)
DRIVING SPEED	All	Slow	Medium	Fast	Medium to fast
BEAM	Diffused glow	Extra-wide	Wide/Shorter	Concentrated/Long	Inner spot & outer flood
RECOMMENDED MOUNTING	Low/Wheel well	All points	Low &/or rear	High points	All points
TERRAIN & RIDING STYLE	Added style & personalization in any terrain	All riding & utility	Wide-open terrain or trails & utility	Trail & tight conditions	All riding & utility

ADD A HARNESS TO MOUNT YOUR LIGHTS

MODEL	LIGHT BAR SET-UPS		
	1 LIGHT IN 1 LOCATION ON 1 SWITCH	2 LIGHTS IN 2 LOCATIONS ON 1 SWITCH	2 LIGHTS IN 2 LOCATIONS ON 2 SWITCHES
2019-2020 ALL MODELS	POLARIS PULSE LED LIGHT BAR HARNESS 2883785	POLARIS PULSE LED LIGHT BAR HARNESS 2883785 Y-HARNESS 2879860	POLARIS PULSE LED LIGHT BAR HARNESS (x2) 2883785

ACCENT LIGHTING

ACCENT LIGHTS

POLARIS GENERAL XP 1000/4 '20-21
POLARIS GENERAL 1000/4 '16-21

COLOR	PN
RED (SET OF 4)	2880500
BLUE (SET OF 4)	2880506

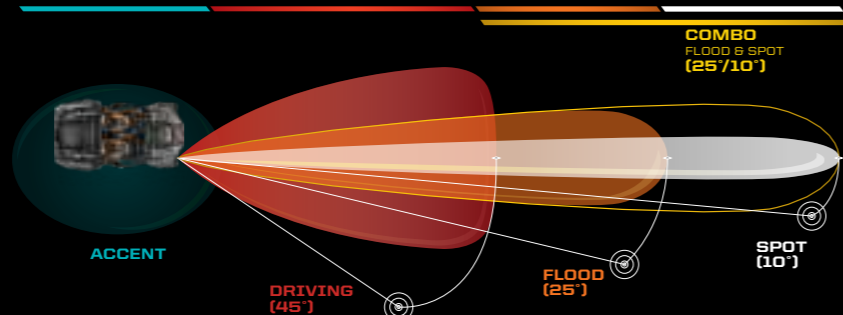

▲ No battery connection cables required on any model/model year POLARIS GENERAL 1000.

PULSE All RIGID and Pro Armor lights are Polaris PULSE ready.

KNOW YOUR TERRAIN



- Tread patterns optimized for extreme traction
- Ideal for both hard pack and loose trail



- Flexible "grippy" tread
- Aggressive side bite



- Provides traction and durability
- Built to perform in hard sand, jagged rocks or any other extreme terrain



- Extra deep treads
- Self-cleaning lugs



- Paddles provide traction and durability in soft sand
- Built to float on top of sand



- Industry leading anti-puncture side walls
- Purpose-built, long lasting tread patterns



- Handles extreme cold
- Holds shape and provides traction

SUPERIOR PERFORMANCE & DURABILITY

WAYS TO SHOP WHEELS & TIRES



LIFELONG PERFORMANCE

- Every tire is designed and constructed with longevity in mind
- 3,000+ mile rated (4,828 kilometers)

PREMIUM PROTECTION

- Pro Armor makes tires with extra protection exactly where it's needed most—the sidewall
- Triple-belted sidewalls keep your tires more resistant so you can keep going

TOUGHEST TIRES

- Higher ply ratings mean added protection
- Pro Armor builds 8 or 10-ply rated tires for higher puncture-resistance



KNOW YOUR TIRES

DIMENSIONS			TREAD DEPTH	TIRE WEIGHT	PLY RATING	SIDEWALL BELTS	LOAD RATING
TIRE HEIGHT	TIRE WIDTH	WHEEL DIAMETER					
32" x 9"	R15	FRONT/REAR	30 mm	18 kg	10	3	499 kg
Part Number			TREAD DEPTH Deeper treads have more grip in all conditions	PLY RATING Indicates tire puncture-resistance	LOAD RATING How much weight can the tire handle	SIDEWALL BELTS Increase your resistance to sidewall punctures	USAGE Where can you use the tire
			TIRE WEIGHT A lighter tire makes for improved vehicle performance				

TIRES BY SIZE

27"	28"	29"	30"
MUD XC	HARVESTER	DUAL-THREAT	CRAWLER XG
HARVESTER	CRAWLER XR	MUD XC	ATTACK 2.0
	ATTACK 2.0	HD-K	HARVESTER
	CRAWLER XG		CRAWLER XG

TIRES BY TERRAIN

TRAIL	ROCK	DESERT	MUD	UTILITY	SNOW
CRAWLER XR	CRAWLER XR	CRAWLER XR	MUD XC	HARVESTER	ATTACK 2.0
CRAWLER XG	CRAWLER XG	CRAWLER XG		PRESERVE	ATTACK
MUD XC	DUAL-THREAT	ATTACK 2.0		XD-K	HARVESTER
ATTACK 2.0	ATTACK 2.0	ATTACK		HD-K	XD-K
ATTACK		DUAL-THREAT			HD-K
DUAL-THREAT					
HARVESTER					
PRESERVE					
XD-K					
HD-K					

WHEELS BY SIZE

14"	15"
40-SERIES (7 TIRE OPTIONS)	50-SERIES (6 TIRE OPTIONS)
4201 (AMPLIFY)	5201 (CYCLONE)
4202 (BUCKLE)	5202 (FLARE)
4301 (COMBAT)	5301 (HALO)
4203 (REBLR)	5203 (HEXLR)
4204 (SHACKLE)	5204 (WYDE)
4205 (SIXR)	
HD DUAL BEADLOCK	

KNOW YOUR WHEELS

STEP 1: SELECT YOUR SERIES

4 = 40-SERIES 5 = 50-SERIES

STEP 2: CHOOSE YOUR LOAD RATING

1 = <800 LBS 2 = 801 - 1,300 LBS 3 = 1,301 - 1,600+ LBS

STEP 3: PICK YOUR STYLE

OFFSET / BEADLOCK / COLOR

INCREASE OFFSET FROM STOCK = NARROWER STANCE
DECREASE OFFSET FROM STOCK = WIDER STANCE

TIRES



FRONT/REAR

PRO ARMOR CRAWLER XR

- Wanna race? This tire grips it all from the trail to the rocks
- Square block profile for even surface contact
- A tougher durometer than the XG to take on the toughest the trail has to offer

		TREAD DEPTH	TIRE WEIGHT	PLY RATING	SIDEWALL BELTS	LOAD RATING	
14"	28" x 10" R14 5415536	FRONT/REAR	16 mm	15 kg	8	3	517 kg



XR

SINGLE DUROMETER

- Smaller lug height, added rigidity and lateral stability when cornering
- Unique lug design excels in hard-packed, fast terrain



FRONT/REAR

PRO ARMOR ATTACK 2.0

- Engineered for excellent hard-pack performance
- Dual-compound technology and radial construction offer performance in all terrains
- Tight thread pattern for a quieter ride

		TREAD DEPTH	TIRE WEIGHT	PLY RATING	SIDEWALL BELTS	LOAD RATING	
18"	28" x 10" R15 5416344	FRONT/REAR	25 mm	15 kg	10	3	503 kg
15"	30" x 10" R15 5416345			17 kg			560 kg



TIGHTER TREAD PATTERN = Better traction in hard pack

DUAL-DUROMETER LUG = Increased grip & traction in rough terrain, smoother

10-PLY RATED = Increased durability

LARGER SIZE OFFERING IN 28" = More ground clearance & trail traction



FRONT/REAR

PRO ARMOR CRAWLER XG

- Big or small, these tires crawl them all
- A soft, sticky compound makes this tire ideal for both rock crawling and desert running
- 8-ply, triple-belted ballistic sidewalls resist punctures

		TREAD DEPTH	TIRE WEIGHT	PLY RATING	SIDEWALL BELTS	LOAD RATING	
14"	30" x 10" R14 5415616		17 kg			581 kg	
15"	28" x 10" R15 5416346	FRONT/REAR	20 mm	15 kg	8	3	498 kg
15"	30" x 10" R15 5416397		18 kg			581 kg	



WHAT CRAWLER ARE YOU?

XG

DUAL-DUROMETER

- Taller lug height
- Perfect balance between high-speed performance, durability and flex in order to grip slick rock



FRONT/REAR

PRO ARMOR ATTACK

- The best all-purpose tire for all-season traction in any terrain
- Unique, full-face tread design
- Harder durometer lugs promote extended wear, increasing tire life
- Wider spaced lugs provide more grip in softer terrain

		TREAD DEPTH	TIRE WEIGHT	PLY RATING	SIDEWALL BELTS	LOAD RATING	
14"	26" x 9" R14 5415613	FRONT	23 mm	13 kg	8	3	413 kg
14"	26" x 11" R14 5415614	REAR		15 kg			599 kg



FRONT/REAR

PRO ARMOR DUAL-THREAT

- Dual-compound technology and radial construction offer performance in all terrains
- Softer durometer rubber on outer edge for overall superior grip and feel
- Harder durometer rubber in the middle for increased traction during acceleration and longer tread life

		TREAD DEPTH	TIRE WEIGHT	PLY RATING	SIDEWALL BELTS	LOAD RATING	
14"	26" x 9" R14 5416340	FRONT	16 mm	12 kg	10	3	413 kg
14"	26" x 11" R14 5416341	REAR		14 kg			499 kg
14"	29" x 9" R14 5416342	FRONT		14 kg			499 kg
14"	29" x 11" R14 5416343	REAR		16 kg			599 kg



DUAL-COMPOUND = MORE GRIP + LONGER LIFE



- 1 Firmer Durometer Rubber = Longer Life
- e Softer Durometer Rubber = More Grip



FRONT/REAR

PRO ARMOR MUD XC

- Designed for the perfect mud-trail crossover for a smooth ride on the trail and aggressive traction in the mud
- Dual-compound technology with harder durometer lugs promote extended wear, increasing tire life
- 10-ply construction, means added protection in the toughest terrain

		TREAD DEPTH	TIRE WEIGHT	PLY RATING	SIDEWALL BELTS	LOAD RATING	
14"	29" x 10" R14 5416946	FRONT/REAR	30 mm	18 kg	10	3	630 kg
14"	27" x 9" R14 5416947	FRONT		14 kg			531 kg
14"	27" x 11" R14 5416948	REAR		15 kg			599 kg



PICKING THE RIGHT UTILITY TIRE

UTILITY FEATURE	HARVESTER	PRESERVE	XD-K	HD-K
8,047 Kilometer Rated Long life and performance	X	X		
10-Ply Rated Higher ply ratings means added protection	X	X	X	X
Low Impact Tread Easy on soil		X		
Heavy Duty Tread Aggressive tread pattern for all day work on farms or ranches	X		X	X
Turf-Friendly Easy on grass and farm yard	X	X		
Aramid Fiber Belt 5x times stronger than steel and lighter			X	X
Wide Range of Sizes For exactly how you want to use your machine	30", 28", 27", 26"	27", 26"	26"	29"



FRONT/REAR

PRO ARMOR PRESERVE

- Turf-friendly for areas where low-impact from tire tread is needed
- Rounded profile and special tread pattern to limit footprint

	TREAD DEPTH	TIRE WEIGHT	PLY RATING	SIDEWALL BELTS	LOAD RATING
12" 26" x 8" R12 5416403	FRONT	11 kg			388 kg
12" 26" x 10" R12 5416402	REAR	13 kg	10	3	599 kg
14" 27" x 10" R14 5416348	FRONT/REAR	13 kg			599 kg



WHEEL SIZE
14" 12"



FRONT/REAR

PRO ARMOR HARVESTER

- All-around work horse with tread life of 8047 km
- Tread pattern designed to withstand anything from the farmyard to the pastures and the trail
- With 10-ply, it can carry the load day in and day out

	TREAD DEPTH	TIRE WEIGHT	PLY RATING	SIDEWALL BELTS	LOAD RATING
12" 26" x 8" R12 5416396	FRONT	11 kg			388 kg
12" 26" x 10" R12 5415966	REAR	15 kg			615 kg
14" 27" x 10" R14 5415965	FRONT/REAR	15 kg	10	3	599 kg
14" 28" x 10" R14 5416347	FRONT/REAR	15 kg			630 kg
15" 30" x 10" R15 5417529	FRONT/REAR	17 kg			599 kg



WHEEL SIZE
15" 14" 12"



FRONT/REAR

PRO ARMOR XD-K

- 26" Aramid fiber-belted tire to tackle any terrain
- Unique full-face tread design
- Harder durometer lugs promotes extended wear, increasing tire life

	TREAD DEPTH	TIRE WEIGHT	PLY RATING	SIDEWALL BELTS	LOAD RATING
12" 26" x 9" R12 5415756	FRONT	13 kg			388 kg
12" 26" x 11" R12 5415757	REAR	15 kg	10	3/1 Aramid	499 kg



WHEEL SIZE
12"



FRONT/REAR

PRO ARMOR HD-K

- Designed to provide a smooth ride and aggressive traction in all riding terrains
- Triple belted sidewall provides extreme sidewall protection and extends the tire life
- Quad belt tread core offers superior protection and longer tread life

	TREAD DEPTH	TIRE WEIGHT	PLY RATING	SIDEWALL BELTS	LOAD RATING
14" 29" x 10" R14 5417507	FRONT/REAR	18 kg	10	3/1 Aramid	598 kg



WHEEL SIZE
14"

WHEELS

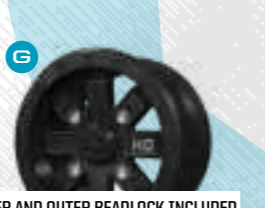

14"

15"

40-SERIES

A 4201 (AMPLIFY) ○

FRONT WEIGHT: 5.9 kg | LOAD RATING: 408 kg | OFFSET: +4
 REAR WEIGHT: 6.4 kg | LOAD RATING: 590 kg | OFFSET: -9
 ACCENT: FRONT 14" x 7" 1522956-266
 REAR 14" x 8" 1522957-266
 MATTE BLACK: FRONT 14" x 7" 1522956-458
 REAR 14" x 8" 1522957-458

B 4202 (BUCKLE) ○

FRONT WEIGHT: 5.8 kg | LOAD RATING: 408 kg | OFFSET: +4
 REAR WEIGHT: 6.1 kg | LOAD RATING: 590 kg | OFFSET: -9
 ACCENT: FRONT 14" x 7" 1522544-266
 REAR 14" x 8" 1522545-266
 MATTE BLACK: FRONT 14" x 7" 1522544-458
 REAR 14" x 8" 1522545-458

C 4301 BEADLOCK (COMBAT) ○

FRONT/REAR WEIGHT: 7.3 kg | LOAD RATING: 729 kg | OFFSET: +38
 ACCENT: FRONT/REAR 14" x 7" 1523284
 MATTE BLACK: FRONT/REAR 14" x 7" 1523283

D 4203 BEADLOCK (REBLR) ○

FRONT WEIGHT: 5.9 kg | LOAD RATING: 408 kg | OFFSET: +4
 REAR WEIGHT: 6.6 kg | LOAD RATING: 590 kg | OFFSET: -9
 MATTE BLACK: FRONT 14" x 7" 1522238-458
 REAR 14" x 8" 1522239-458

E 4204 (SHACKLE) ○

FRONT WEIGHT: 5.9 kg | LOAD RATING: 408 kg | OFFSET: +4
 REAR WEIGHT: 6.4 kg | LOAD RATING: 590 kg | OFFSET: -9
 ACCENT: FRONT 14" x 7" 1522546-266
 REAR 14" x 8" 1522547-266
 MATTE BLACK: FRONT 14" x 7" 1522546-458
 REAR 14" x 8" 1522547-458

F 4205 (SIXR) ○

FRONT WEIGHT: 4.8 kg | LOAD RATING: 408 kg | OFFSET: +4
 REAR WEIGHT: 5.7 kg | LOAD RATING: 590 kg | OFFSET: -9
 MATTE BLACK: FRONT 14" x 7" 1521507-521
 REAR 14" x 8" 1521508-521
 LUSTER: FRONT 14" x 7" 1521507-410
 REAR 14" x 8" 1521508-410

NEW HD DUAL BEADLOCK

FRONT/REAR WEIGHT: 18.1 kg | LOAD RATING: 725.7 kg | OFFSET: +38
 MATTE BLACK: FRONT/REAR 14" x 7" 1524022-458



14" FORGED BEADLOCK RINGS

Only used on 4203 (REBLR) PART #

A	Voodoo Blue	1522244-619
B	Machined	1522244-266
C	White	1522244-133
D	Indy Red	1522244-293
E	Orange Crush	1522244-589

15" FORGED BEADLOCK RINGS

Only used on 5203 (HEXLR) PART #

C	Matte Black - Replacement	1523147-458
---	---------------------------	-------------

50-SERIES

H 5201 (CYCLONE) ○

FRONT/REAR WEIGHT: 7.8 kg | LOAD RATING: 590 kg | OFFSET: +4
 ACCENT: FRONT/REAR 15" x 7" 1523184-266
 MATTE BLACK: FRONT/REAR 15" x 7" 1523184-458

I 5301 BEADLOCK (HALO) ○

FRONT/REAR WEIGHT: 7.7 kg | LOAD RATING: 726 kg | OFFSET: +38
 ACCENT: FRONT/REAR 15" x 7" 1523282
 MATTE BLACK: FRONT/REAR 15" x 7" 1523266

J 5204 (WYDE) ○

FRONT/REAR WEIGHT: 6.1 kg | LOAD RATING: 590 kg | OFFSET: +55
 MATTE BLACK: FRONT/REAR 15" x 7" 1522550-458

K 5202 (FLARE) ○

FRONT/REAR WEIGHT: 8.1 kg | LOAD RATING: 590 kg | OFFSET: +4
 ACCENT: FRONT/REAR 15" x 7" 1523102-266
 MATTE BLACK: FRONT/REAR 15" x 7" 1523102-458

L 5203 BEADLOCK (HEXLR) ○

FRONT/REAR WEIGHT: 7.3 kg | LOAD RATING: 590 kg | OFFSET: +38
 MATTE BLACK: FRONT/REAR 15" x 7" 1522435-458

○ LUG NUTS REQUIRED

KNOW YOUR WHEELS

STEP 1: SELECT YOUR SERIES

4 = 40-SERIES 5 = 50-SERIES

STEP 2: CHOOSE YOUR LOAD RATING

1 = <800 LBS 2 = 801 - 1,300 LBS 3 = 1,301 - 1,600+ LBS

STEP 3: PICK YOUR STYLE

OFFSET / BEADLOCK / COLOR

INCREASE OFFSET FROM STOCK = NARROWER STANCE
 DECREASE OFFSET FROM STOCK = WIDER STANCE

KNOW YOUR TERRAIN



• Tread patterns optimized for extreme traction
 • Ideal for both hard pack and loose trail



• Extra deep treads
 • Self-cleaning lugs



• Industry leading anti-puncture side walls
 • Purpose-built, long lasting tread patterns



• Flexible "grippy" tread
 • Aggressive side bite

WHEEL & TIRE SETS

14"
40-SERIES

TRAIL

DUAL-THREAT 29" 4828 km

MUD

MUD XC 27" 4828 km

UTILITY

MUD XC 29" 4828 km

UTILITY

HARVESTER 27" 8047 km

UTILITY

HARVESTER 28" 8047 km

ROCK

CRAWLER XG 30" 4828 km

CRAWLER XR 28" 4828 km

REPLACEMENT CAPS

POLARIS

LUSTER	ALL WHEELS EXCEPT 5203 (HEXLR) & 5204 (WYDE)	1521508-410
MATTE BLACK		1521509-521
LUSTER	5203 (HEXLR)	1522243-410
MATTE BLACK		1522243-458
NEW HD DUAL BEADLOCK	ALL WHEELS	5457498-458

PRO ARMOR

LUSTER	ALL WHEELS EXCEPT 5203 (HEXLR) & 5204 (WYDE)	5453209-410
MATTE BLACK		5453209-458
MATTE BLACK	5204 (WYDE)	1523063-458
LUSTER	5203 (HEXLR)	1523015-410
MATTE BLACK		1523015-458

12mm x 1.5 SPLINED LUG NUTS

○ LUG NUTS REQUIRED

16 SPLINED LUG NUTS WITH WRENCH ADAPTER	2879332
4 SPLINED LUG NUTS WITHOUT WRENCH	2879331
12mm x 1.5 SPLINED LUG WRENCH	2204966

COLBY VALVE SHORT ULTIMATE VALVE - 2 PACK

» 2883293
 COLBY COMBO VALVE KIT (16 PACK)
 • Includes 8 ultimate valves and 8 emergency valves
 » 2883294

15"
50-SERIES

TRAIL

ATTACK 2.0 28" 4828 km

ATTACK 2.0 30" 4828 km

UTILITY ROCK

NEW HARVESTER 30" 8047 km

CRAWLER XG 28" 4828 km

CRAWLER XG 30" 4828 km

5201 (CYCLONE) Accent	2883160	2883169		2883188	2883178
5201 (CYCLONE) Matte Black	2883159	2883168		2883187	2883178
5202 (FLARE) Accent	2883158	2883167	2885045	2883186	2883177
5202 (FLARE) Matte Black	2883157	2883166	2885046	2883185	2883176
5301 (HALO) Accent	2883162	2883171	2885047	2883190	2883181
5301 (HALO) Matte Black	2883161	2883170	2885048	2883189	2883180
5203 (HEXLR) Matte Black	2883154	2883163	2885049	2883182	2883173
5204 (WYDE) Matte Black	2883155	2883164	2885051	2883183	2883174

○ LUG NUTS REQUIRED

2 WAYS TO PURCHASE

INDIVIDUAL WHEELS & TIRES - OR - COMPLETE SETS AS LISTED

Exclusively at Polaris Authorized Dealers

WINCHES

TESTED **1,200+**
PULLS AT MAX LOAD

OPERATES FULLY
SUBMERGED

BUILT TO WITHSTAND
-29° C TEMPERATURES

MILITARY
TESTED & APPROVED



FEATURES

PRO PRO HEAVY DUTY SERIES

HD HEAVY DUTY SERIES

ALL POLARIS ENGINEERED
WINCHES COME WITH:

- ✓ FAST WIRE CONNECTION TO POLARIS PULSE SYSTEM
- ✓ HOOK WITH STRAP
- ✓ CUT STEEL GEARS & SEALED DRIVETRAIN
- ✓ SEALED PERMANENT MAGNET MOTOR



1. Set Dial to FREE SPOOL (N) to attach Winch Hook
2. Set Dial to PULL (L) for Winch Mode
3. Set Dial to ROPE RECOVERY (H) for 5x Faster Rope Recovery



NOT AVAILABLE

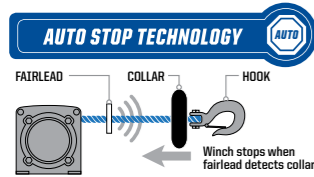

Stops winch at end of pull to prevent driveline stress and plow overlifting



WITH ALUMINUM FAIRLEAD

ADD AUTO STOP UPGRADE

2881288
SYNTHETIC ROPE REQUIRED



WITH STEEL ROLLER FAIRLEAD

PREMIUM SYNTHETIC ROPE

- Lightweight & Easy to Handle
- Superior Flexibility & Strength
- 15 m Long



ADD SYNTHETIC ROPE

2879187



WIRELESS REMOTE

15 m range wireless remote control with unique code for interference-free operation



ADD WIRELESS REMOTE

2881287



MODEL	2041 kg	2041 kg
POLARIS GENERAL XP 1000/4 '20-21	2883861	2883860
POLARIS GENERAL 1000/4 '19-21		

PLOWS & TRACKS

GLACIER PRO HD PLOW SYSTEM

» 183 cm or 168 cm Blades » Choice of poly or steel » Manual angle system standard



43 cm
168 cm POLY BLADE
BEST FOR CORROSION RESISTANCE

43 cm
183 cm STEEL BLADE
BEST FOR BIG JOBS YEAR AFTER YEAR

CREATE YOUR PLOW SYSTEM	STEP 1 SELECT A MOUNT	STEP 2 SELECT A FRAME	STEP 3 SELECT A LIFT METHOD	STEP 4 SELECT A BLADE	STEP 5 SELECT ACCESSORIES
MODELS	MOUNT	FRAME	WINCH	BLADES	ACCESSORIES
POLARIS GENERAL XP 1000/4 '20-21	2881763	2880260 TOP SELLER	Polaris PRO HD 2041 kg Winch 2883861 POLARIS GENERAL XP 1000/4 '20-21 POLARIS GENERAL 1000/4 '19-21	183 cm Steel 2880270 168 cm Poly 2880269 168 cm Steel 2880268	183 cm Blade Snow Deflector 2858541 183 cm HD Wear Bar 2879875 183 cm Wear Bar 2204976 168 cm Blade Snow Deflector 2879866 168 cm HD Wear Bar 2879868 168 cm Wear Bar 2879867 Plow Marker 2872726 168 cm Blade Plow Shoe 2208864 Shear Pin 2205527 Replacement T Shear Pin 2204829 Extension for Tracks 2880267 Heavy Duty Deflector 2884160
POLARIS GENERAL 1000/4 '16-21			Hydraulic Plow Angle 2885102 POLARIS GENERAL 1000/4 '16-18 Hydraulic Plow Controller 2883391 POLARIS GENERAL XP 1000/4 '20-21 POLARIS GENERAL 1000/4 '16-21		

GLACIER HD PLOW SYSTEM

» 168 cm Blades » Choice of poly or steel » Manual angle system standard



43 cm
168 cm POLY BLADE
BEST FOR CORROSION RESISTANCE

43 cm
168 cm STEEL BLADE
BEST FOR BIG JOBS YEAR AFTER YEAR

DURABLE BLADES
Choose a steel blade for longevity and increased rigidity or a lightweight non-stick, poly blade that's easier on plowing surfaces.

CREATE YOUR PLOW SYSTEM	STEP 1 SELECT A MOUNT	STEP 2 SELECT A FRAME	STEP 3 SELECT A LIFT METHOD	STEP 4 SELECT A BLADE	STEP 5 SELECT ACCESSORIES
MODELS	MOUNT	FRAME	WINCHES	BLADES	ACCESSORIES
POLARIS GENERAL XP 1000/4 '20-21	2883256	2882927	Polaris HD 2041 kg Winch 2883860 POLARIS GENERAL XP 1000/4 '20-21 POLARIS GENERAL 1000/4 '19-21	168 cm Poly 2880269 168 cm Steel 2880268	168 cm Blade Snow Deflector 2879866 168 cm HD Wear Bar 2879868 168 cm Wear Bar 2879867 Plow Marker 2872726 168 cm Plow Shoe 2208864 Shear Pin 2205527 Replacement T Shear Pin 2204829
POLARIS GENERAL 1000/4 '16-21					



PROSPECTOR PRO TRACK MOUNTS

• Install in place of tires and wheels. Tracks sold separately.

» 2880649
POLARIS GENERAL 1000/4 '16-21

NEW! FALL AVAILABILITY
» 2885117
POLARIS GENERAL XP 1000/4 '20-21

PROSPECTOR PRO TRACK

» 2880758

POLARIS GENERAL 1000/4 '16-21
POLARIS GENERAL XP 1000/4 '20-21
If using Glacier Pro Plow System, Track Plow Extension is required (2880267)

ACCESSORIES

WINDSHIELDS & REAR PANELS

DOORS

ROOFS & PROTECTION

STORAGE CAB COMFORT & HUNT

COOLERS

RIDE COMMAND & AUDIO

LIGHTING

WHEELS & TIRES

WINCHES & PLOWS

FOR THE LIFE OF YOUR RIDE

POLARIS ENGINEERS PARTS THAT PUSH THE LIMITS WITHOUT SACRIFICING STRENGTH AND DURABILITY. We build our products so anyone with the right tools can maintain their vehicle from their own garage - and get them back on the trails where they belong.

MAINTENANCE TIP

BREAK-IN PERIOD

The break-in period for your new GENERAL is the first 25 hours of operation, or the time it takes to use the first two tanks of fuel. No single action on your part is as important as a proper break-in period. Careful treatment of a new engine will result in more efficient performance and longer life for the engine.

NOTICE: Excessive heat build-up during the first three hours of operation will damage close-fitted engine parts. Do not operate at full throttle or high speeds for extended periods during the first three hours of use.

AIR FILTERS

A clogged air filter can restrict air flow to the engine leading to reduced engine performance, engine life or catastrophic failure.

BRAKE PADS

Maintaining and/or replacing brakes are critical to the safety and functionality of a vehicle. Brake pads should be checked for wear and oil or grease (petroleum products) contamination and brake discs should be checked for cracks, excessive corrosion or warping.

HALF SHAFT

Check for tear and punctures in the boot which can lead to CV joint wear that can contribute to axle failure.

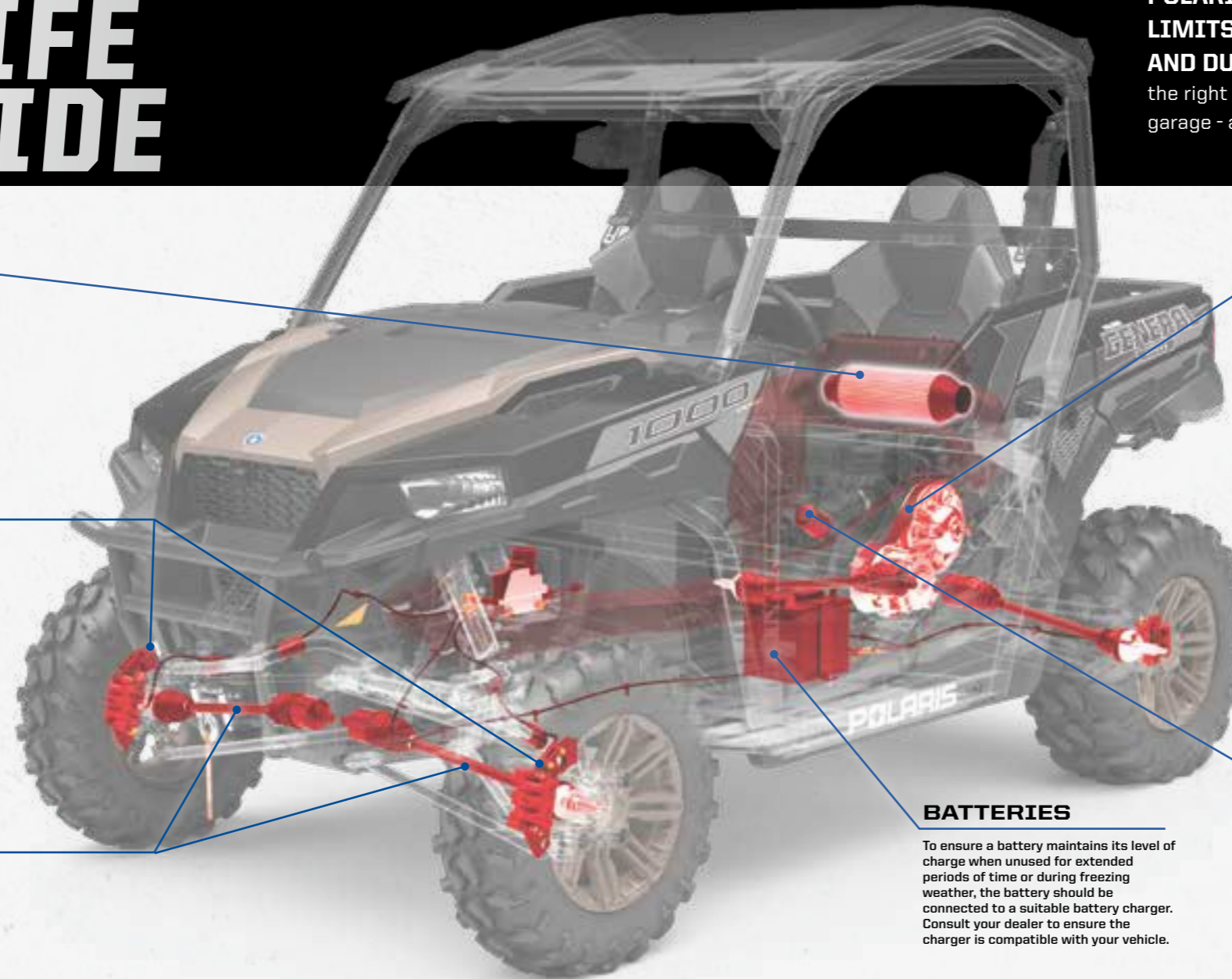

DRIVE BELTS

Polaris Engineered belts deliver unmatched performance for your off-road vehicle. Developed and tested on all our engines for all environments and conditions. Check your belt for delamination, hour glassing and glazing.

BREAK-IN PERIOD

- Use lower gear (if available) while varying speeds and avoiding wide open throttle for 8-16 km
- If no low gear is available, vary at moderate speeds while avoiding wide open throttle for 80 km

OUR INVESTMENT

- 32,187 km of field testing
- Thousands of dyno hours
- 18+ months of development (3,000+ design hours) per belt
- 1200+ vehicle validation hours
- Collaboration with powertrain & clutch engineers

YOUR ADVANTAGE

- No clutch recalibration
- Less wear & tear due to heat
- Ensure maximum vehicle performance
- More time riding, less time wrenching
- Produced in collaboration with powertrain and clutch engineers to ensure a perfect fit, maximum performance and ultimate durability

BATTERIES

To ensure a battery maintains its level of charge when unused for extended periods of time or during freezing weather, the battery should be connected to a suitable battery charger. Consult your dealer to ensure the charger is compatible with your vehicle.

OIL FILTERS

Change oil filters with every oil change to provide the best engine protection and keep the engine operating at peak performance.

FOLLOW RECOMMENDED SERVICE INTERVALS IN THE OWNER'S MANUAL

MAINTENANCE SCHEDULE

25 HRS / 400 km

BREAK-IN MAINTENANCE

- ENGINE OIL:** CHANGE
- GENERAL LUBRICATION:** ALL FITTINGS, PIVOTS, CABLES, ETC.
- AIR FILTER:** INSPECT & REPLACE AS NEEDED
- EXHAUST SYSTEM:** INSPECT & CLEAN
INSPECT FOR LEAKAGE OR CARBON BUILD UP AT JOINTS
INSPECT & CLEAN SCREEN TYPE SPARK ARRESTOR

50 HRS / 800 km

6 MONTHS

- EXHAUST SYSTEM:** INSPECT & CLEAN
INSPECT FOR LEAKAGE OR CARBON BUILD UP AT JOINTS
INSPECT & CLEAN SCREEN TYPE SPARK ARRESTOR
- GENERAL LUBRICATION:** ALL FITTINGS, PIVOTS, CABLES, ETC.
- DRIVE BELT:** INSPECT & ADJUST
REPLACE AS NEEDED

100 HRS / 1600 km

12 MONTHS

- ENGINE OIL:** CHANGE
- DRIVE BELT:** INSPECT & ADJUST
REPLACE AS NEEDED
- TRANSMISSION FLUID:** CHANGE
- AIR FILTER:** INSPECT & REPLACE AS NEEDED
- EXHAUST SYSTEM:** INSPECT & CLEAN
INSPECT FOR LEAKAGE OR CARBON BUILD UP AT JOINTS
INSPECT & CLEAN SCREEN TYPE SPARK ARRESTOR

150 HRS / 2400 km

18 MONTHS

- ENGINE OIL:** CHANGE
- BATTERY:** TEST, CLEAN, & CHECK FLUID LEVEL
REPLACE AS NEEDED
- DRIVE BELT:** INSPECT & ADJUST
REPLACE AS NEEDED
- TIRES:** INSPECT CONDITION & PRESSURE
- EXHAUST SYSTEM:** INSPECT & CLEAN
INSPECT FOR LEAKAGE OR CARBON BUILD UP AT JOINTS
INSPECT & CLEAN SCREEN TYPE SPARK ARRESTOR

200 HRS / 3200 km

24 MONTHS

- ENGINE OIL:** CHANGE
- BRAKE PADS & FLUID:** INSPECT & CLEAN
REPLACE BRAKE FLUID
REPLACE AS NEEDED
- SPARK PLUGS:** INSPECT
REPLACE AS NEEDED
- AIR FILTER:** INSPECT & REPLACE AS NEEDED
- EXHAUST SYSTEM:** INSPECT & CLEAN
INSPECT FOR LEAKAGE OR CARBON BUILD UP AT JOINTS
INSPECT & CLEAN SCREEN TYPE SPARK ARRESTOR

250 HRS / 4023 km

30 MONTHS

- ENGINE OIL:** CHANGE
- BATTERY:** TEST, CLEAN, & CHECK FLUID LEVEL
REPLACE AS NEEDED
- DRIVE BELT:** INSPECT & ADJUST
REPLACE AS NEEDED
- GENERAL LUBRICATION:** ALL FITTINGS, PIVOTS, CABLES, ETC.
- EXHAUST SYSTEM:** INSPECT & CLEAN
INSPECT FOR LEAKAGE OR CARBON BUILD UP AT JOINTS
INSPECT & CLEAN SCREEN TYPE SPARK ARRESTOR

300 HRS / 4828 km

36 MONTHS

- ENGINE OIL:** CHANGE
- AIR FILTER:** INSPECT & REPLACE AS NEEDED
- GEARCASE & TRANSMISSION:** REPLACE FLUIDS
- EXHAUST SYSTEM:** INSPECT & CLEAN
INSPECT FOR LEAKAGE OR CARBON BUILD UP AT JOINTS
INSPECT & CLEAN SCREEN TYPE SPARK ARRESTOR

CHECK YOUR OWNER'S MANUAL FOR ADDITIONAL RECOMMENDED SERVICE ITEMS AND VEHICLE-SPECIFIC TIMING



SPECIFIC NEEDS, SPECIFIC OILS

Polaris invests millions in engine development, and part of that investment is making sure its lubricants—critical to engine performance—are the right formula for your specific engine. The amount of testing data and engineering resources used in developing Polaris lubricants would overwhelm an aftermarket company. Therefore, the aftermarket must spec an oil to an industry-wide standard that must account for a variety of operating parameters.

PS-4 is designed specifically for Polaris 4-cycle engines and has high film strength and wear protection under extreme loads and temperatures. Exclusive anti-wear additives protect engine parts with extra rust and corrosion protection.

PS-4 FULL-SYNTHETIC OIL

• PS-4 is optimal for ambient operating temperatures of -40° C to 38° C

- 1L • 2877263
- 4L • 2877264
- 25L • 2877868
- 60L • 502338
- 200L • 2878003

PS-4 EXTREME-DUTY FULL-SYNTHETIC OIL

• PS-4 Extreme Duty is optimal for ambient operating temperatures of -18° C to 53° C

- 1L • 2879037
- 4L • 2879251
- 25L • 2879252
- 60L • 2879003
- 200L • 2879038

PS-4 OIL CHANGE KIT

• Contains the correct amount of oil for your vehicle and correct oil filter

- » 2202166
SINGLE 570, TWIN 600, TWIN 700, TWIN 800
- » 2879323
RANGER/RZR 900/1000
- » 2880913
POLARIS ACE/ETX 325
- » 2877473
330500, SPORTSMAN 550/850/1000

POLARIS

ENGINEERED PARTS
& LUBRICANTS

FOR THE LIFE OF YOUR RIDE ONLY THE BEST WILL DO

To create the best oil for any terrain, we invest in rigorous testing to ensure our oil delivers the consistency and performance you demand. The results are Polaris Engineered Lubricants that are tested and perfected to deliver excellent total engine protection for the life of your ride.

WHAT COUNTS IN OIL TESTING:

1. Does it protect the engine at high temperatures?
2. Does it keep the engine free from carbon and buildup?
3. Does the oil hold its viscosity over time?

ENGINE CHECKPOINTS

When evaluating an engine oil and its ability to protect and preserve the engine's power output and lifespan, Polaris engineers focus on key areas within the engine, some of the most critical ones include:

RING LANDS: Poor oxidative performance can lead to carbon and varnish buildup, which results in poor ring seal and loss of power, combustion blow by and fuel dilution of the oil.

PISTON RINGS: During the combustion process, extreme pressures are placed on the top ring, forcing it outward toward the cylinder wall, sealing the combustion chamber. With so much force applied, poor oil film strength between the top ring and the cylinder wall can lead to cylinder wear and loss of power.

ROD BEARINGS: Engine bearings ride on an extremely thin hydrodynamic film of oil. Poor oil film strength or using an oil with a thinner viscosity, can lead to premature bearing wear or even engine failure. Using an oil with high film strength and a strong viscosity, like PS-4 full synthetic, will extend the service life of your engine.

CAMSHAFT: Direct Acting Overhead Camshafts are used on many Polaris Prostar Engines. In this application the camshaft pushes directly on the valve, creating very high contact pressures compared to other camshaft configurations. These forces are so great that inferior oil can break down and be forced out of the contact area leading to increased wear. PS-4 full synthetic additives are specifically designed to provide wear protection against this.

OIL DEVELOPMENT

**12 DEDICATED
TEAM MEMBERS**

**FOCUSED ON
POLARIS OIL**

**18+
MONTHS**

**DEVELOPMENT
& TESTING**

**75,000+
HOURS**

**DYNO
TESTING**

**64,374
KILOMETERS**

**FIELD
TESTING**

ENGINEERED TO MAXIMIZE THE LIFE OF YOUR RIDE

All Polaris fluids—from anti-freeze to brake fluid—are developed for your vehicle. Trust the only fluids perfectly engineered for your needs.

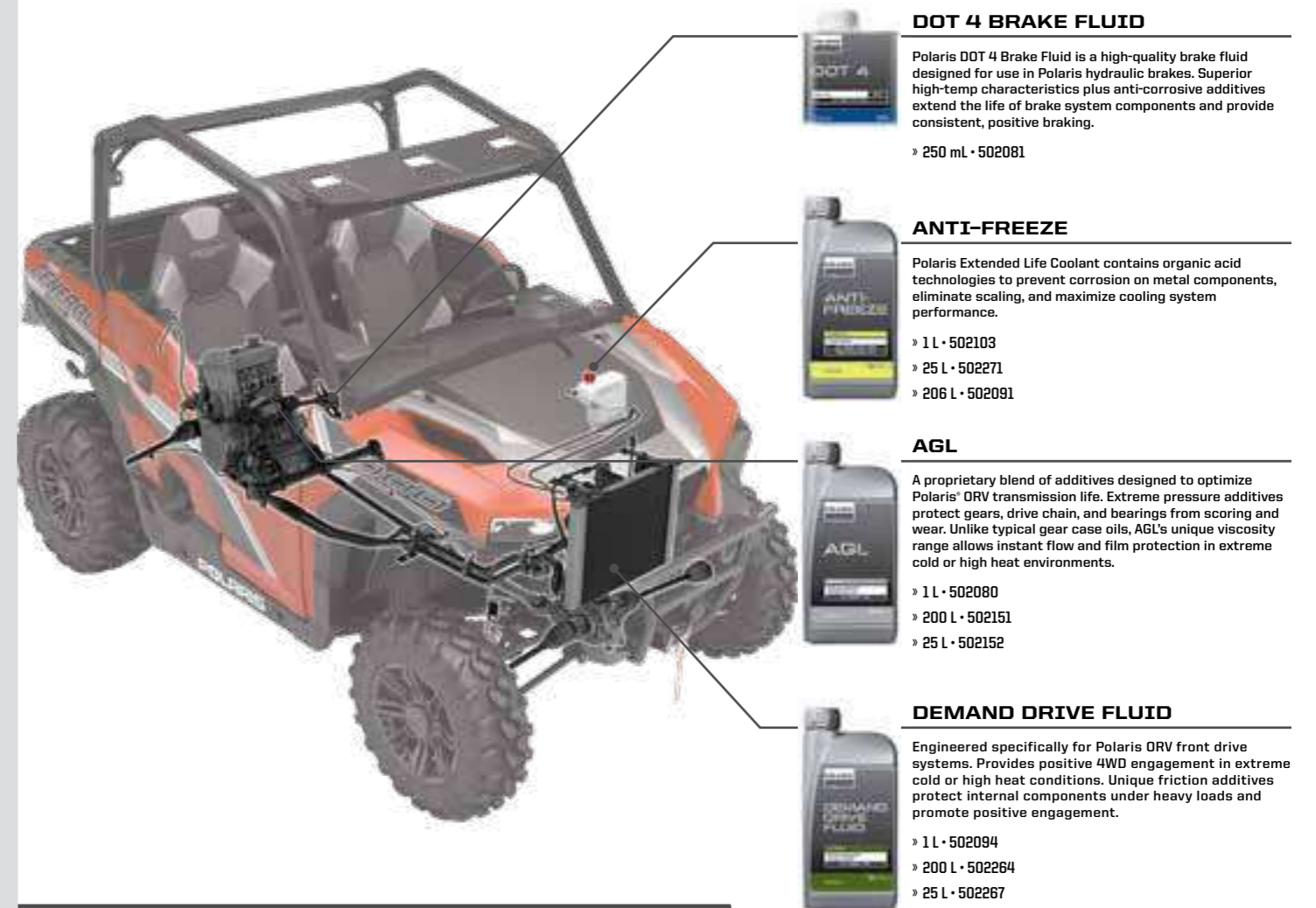

DOT 4 BRAKE FLUID

Polaris DOT 4 Brake Fluid is a high-quality brake fluid designed for use in Polaris hydraulic brakes. Superior high-temp characteristics plus anti-corrosive additives extend the life of brake system components and provide consistent, positive braking.

- » 250 mL • 502081

ANTI-FREEZE

Polaris Extended Life Coolant contains organic acid technologies to prevent corrosion on metal components, eliminate scaling, and maximize cooling system performance.

- » 1L • 502103
- » 25L • 502271
- » 206L • 502091

AGL

A proprietary blend of additives designed to optimize Polaris' ORV transmission life. Extreme pressure additives protect gears, drive chain, and bearings from scoring and wear. Unlike typical gear case oils, AGL's unique viscosity range allows instant flow and film protection in extreme cold or high heat environments.

- » 1L • 502080
- » 200L • 502151
- » 25L • 502152

DEMAND DRIVE FLUID

Engineered specifically for Polaris ORV front drive systems. Provides positive 4WD engagement in extreme cold or high heat conditions. Unique friction additives protect internal components under heavy loads and promote positive engagement.

- » 1L • 502094
- » 200L • 502264
- » 25L • 502267

Proper lubricant application and timing will ensure optimal vehicle performance. Please refer to your owner's manual for lubricant change interval schedules.



CARBON CLEAN

Polaris Carbon Clean prevents ethanol corrosion, stabilizes fuel, and cleans fuel injectors, piston ring lands, intake systems, and combustion chambers. Helps maintain peak HP and improves fuel economy.

- » 125 mL • 502082



FUEL STABILIZER

Fuel Stabilizer prevents ethanol corrosion and stabilizes fuel for up to 2 years. Dual-antioxidant formula protects against gum and varnish for easy starting.

- » 125 mL • 502100



ANGLE DRIVE FLUID

SPORTSMAN,
RANGER, RZR
ANGLE DRIVE GEAR
CASE SYSTEMS

- » 1L • 502089
- » 25L • 502268
- » 202L • 502266



PREMIUM GAS SHOCK OIL

- » 1L • 502098



ALL-SEASON GREASE TUBE

- » 400 g • 502068

SERVICE PARTS

Polaris Engineered service parts deliver unmatched performance and fit for your off-road vehicle.

All service parts are engineered specifically for your machine. Which means everything is designed, tested and perfected to maximize the life of your ride. Getting Polaris Engineered parts is a decision that pays off in the long run, because it ensures there is a long run.

 **PARTS FINDER** VISIT YOUR POLARIS DEALER TO SHOP FOR SERVICE PARTS.

OVER
100,000
PARTS
AVAILABLE!



FOR THE LIFE OF YOUR RIDE

Maintenance is the key to keeping your Polaris off-road vehicle performing at its peak. Items like belts, lubricants, and batteries represent only a few of these critical items engineered specifically by Polaris.



POLARIS ENGINEERED DRIVE BELTS

TESTED, PERFECTED

We test each belt on the intended vehicle - we don't just try to make an existing belt "just work".

- Amery Kuhl, Polaris CVT System Engineer

OUR INVESTMENT

- 32,187 km of field testing
- Thousands of dyno hours
- 18+ months of development (3,000+ design hours) per belt
- 1200+ vehicle validation hours
- Collaboration with powertrain & clutch engineers

YOUR ADVANTAGE

- No clutch recalibration
- Less wear & tear due to heat
- Ensure maximum performance of your vehicle
- More time out riding, less time wrenching

**OUR INVESTMENTS ENSURE POLARIS BELTS
OUTPERFORM YOUR EXPECTATIONS.**

HD HEAVY DUTY PARTS



All Polaris parts are developed and tested to help you get the most out of your ride. Now, we're taking the passion of our riders, workers, and outdoor enthusiasts to the next level with HD Parts.

Engineered & designed for:

- Greater durability
- Enhanced performance
- Greater wear & tear capabilities
- All weather conditions

NEW WHEELS & TIRES

Class leading durability for off-road performance and traction for confident driving in extreme conditions.

- » 1524022-458 • HD WHEEL - 14x7 (SHOWN)
- » 5417507 • PRO ARMOR HD-K - 29x10R14 (SHOWN)
- » 5457498-458 • HD WHEEL CENTER CAP (SHOWN)
- » 5415756 • PRO ARMOR XD-K FRONT
- » 5415757 • PRO ARMOR XD-K REAR

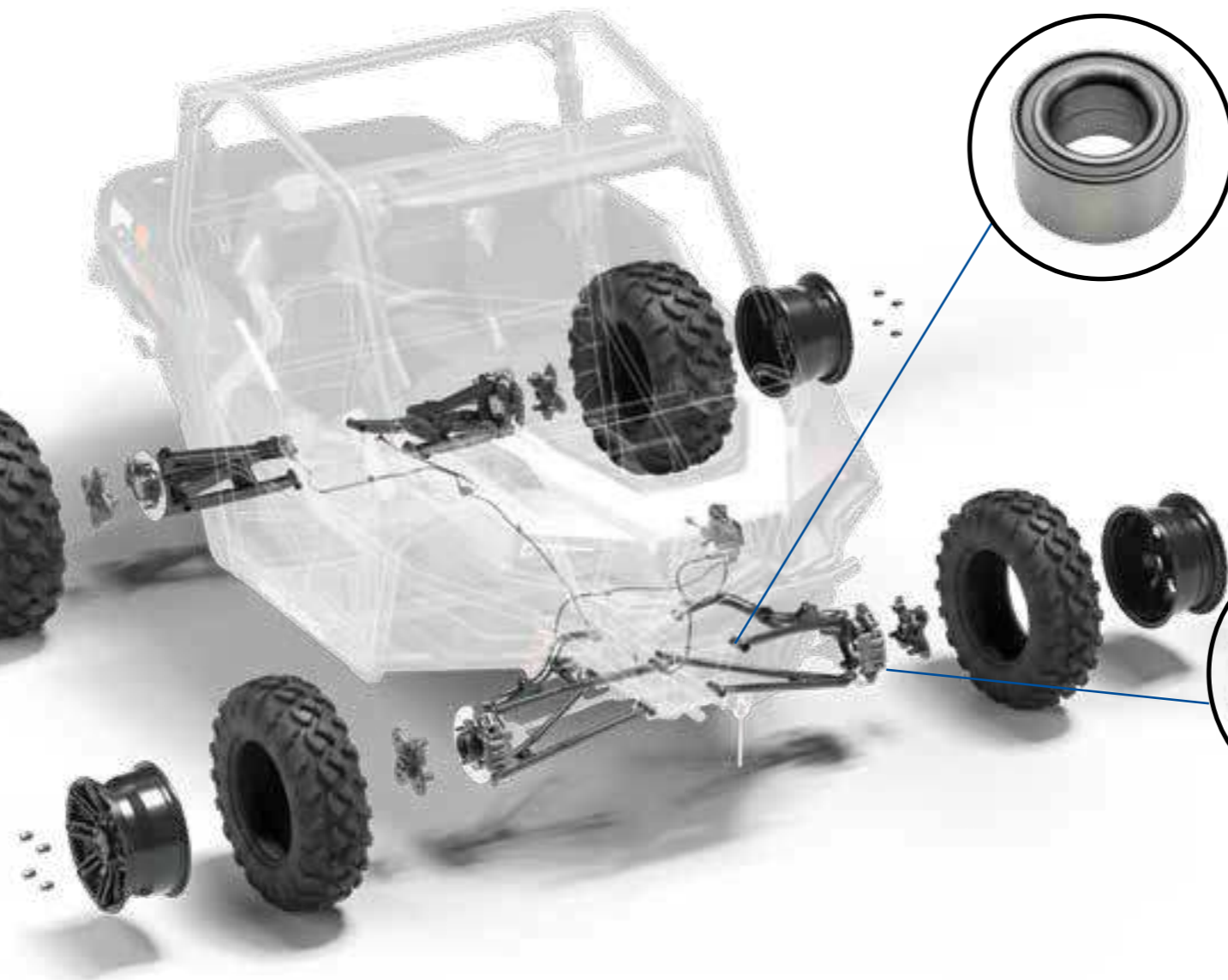

NEW WHEEL BEARINGS

Fully sealed for added protection against intrusions. Made of a higher grade steel for extended life in extreme conditions.

LOCATION	OE	HD HEAVY DUTY PARTS
FRONT WHEEL BEARING	3514924	3515090
REAR WHEEL BEARING		



COMING SOON BRAKES

Engineered to provide longer life and better stopping power while riding in extreme conditions.

*Claims made based off testing and performance of Polaris HD Parts against standard OEM parts made by Polaris and competitor brands under normal use.

For more information regarding Polaris HD parts including vehicle compatibility, installation, and maintenance, please contact your authorized Polaris ORV dealer.

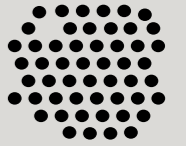

SAND



MUD



WATER



EXTREME COLD



EXTREME HEAT UP TO 54° C



HEAVY PAYLOADS

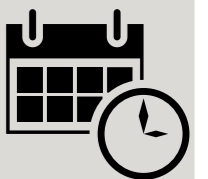

EXTENDED LIFE

CV BOOT REPAIR KIT

FIX ON THE GO | TEMPORARY COVERAGE

- A quick trail side fix to increase trail time
- The flexible and durable boot material expands over a cone tool for CV boot repairs, without disassembling CV axles
- Universal fit - works as a temporary fix for most powersports axles
- All components fit inside the cone, and a cover is provided for compact durable storage
- Easily fits in a cargo box, attached to the roll cage, in the glovebox, or many other storage locations



Items shown are contained inside cone

UTV CV BOOT REPAIR KIT

Kit includes the following items:

- (1) Expandable XL CV Boot
- (1) Reusable Cone Tool
- (2) CV Boot Clamps
- (1) Tube of Silicone Lube
- (1) Grease Packet
- (1) Cone Cover

» 2830526

UTV TRAIL BOOT ONLY

» 2830527

ATV

» CV REPAIR KIT 2830528

» TRAIL BOOT ONLY 2830529

HOW TO INSTALL

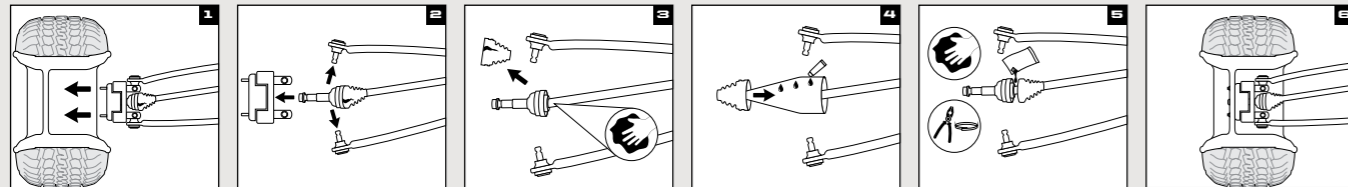

Remove wheel and axle nut.

Remove brake caliper, hub, tie rod, & upper & lower ball joints.

Remove old boot & clean joint.

Spread silicone lube on entire cone tool. Slide boot over cone tool, large end first. See package for outer boot instructions.

Empty the bag of grease into the CV joint/boot, clean sealing points & install clamps.

Reassemble tie rod, ball joints, brake caliper, axle nut, tire & wheel.

Refer to your service manual for further instructions and torque specifications.
*Designed for temporary CV boot repair. Purchase the OEM CV Boot for a permanent repair.

KEEP IT CLEAN

CLEAN

ALL-PURPOSE CLEANER

- Professional cleaner, which is formulated with a low pH-value. The product spreads well on surfaces and adheres on them for effective cleaning action. Perfectly compatible with rubber, plastic and painted surfaces. The formulation is biodegradable.

» 500 mL • 502309

SHINE

INSTANT SHINE & DETAILER

- The INSTANT SHINE AND DETAILER is developed for cleaning action without water. Removes insects, dust and dirt with almost no effort. Applicable for plastics, visors, windscreens, paint and metal. The wipe and shine formulation makes surfaces shine, works water repellent and also has an antistatic effect. Perfect for customers living in urban areas with no access to water, for bike trips or showroom bikes.

» 500 mL • 502303



TRAILERING



CALIBER RAMP PRO

- Designed for ATVs and UTVs up to 127 cm wide
- Integrated grip glides for ultimate traction
- Folding sides for easy transportation & storing

» 132 cm x 229 cm • 2884576



ALUMINUM ARCHED LOADING RAMP

- » 193 cm x 30.5 cm • 907 kg • 2875384
- » 224 cm x 30.5 cm • 1361 kg • 2875386



LIGHTWEIGHT TRI-FOLD RAMP

- Ramp folds up for transport
- Capacity for up to 680.7 kg
- Safety straps included
- » 183 cm x 130 cm • 2875385
- » 208 cm x 130 cm • 2875860



FOLDING ALUMINUM ARCHED RAMP

- Ramp folds up for transport
- Capacity up to 1361 kg
- Safety straps included
- » 224 cm x 30.5 cm • 2875387

HITCHES

3:1 HITCHES

VERSATILE 3 IN 1 FUNCTIONALITY

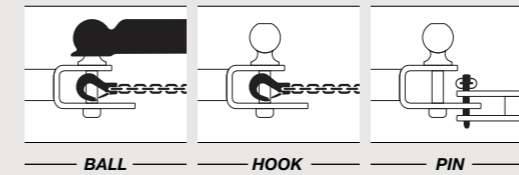

- Ball, pin and hook design
- Durable, rust resistant steel with black powdercoated finish
- Removable ball
- HD 1.6 cm pin and clip



HITCH WITH 5 cm BALL

- » 5 cm x 5 cm RECEIVER 2830522
- » 3 cm x 3 cm RECEIVER 2830523



4.8 cm BALL

- 4.8 cm replacement ball for hitch
- Designed to work with 3:1 Hitch
- » 2830524



RECEIVER HITCH

- » 5 cm RECEIVER TONGUE 2875320
- » FRONT HITCH RECEIVER 2878846



TRAILER BALL 1.9 cm SHANK

- » 4.8 cm BALL • 2877602
- » 5 cm BALL • 2877603

STRAPS & ROPES



RECOVERY STRAP

- 5 cm x 9.1 m (8165 kg)
- Comes with carry bag
- » 2884033



RATCHET STRAP

- 3.8 cm x 4.6 m straps, 2 Pack
- Heavy duty webbing
- 2495 kg maximum load, 831 kg working load
- » 2884031



RATCHET STRAP

- 5 cm x 6.1 m Ratchet Straps
- Heavy duty webbing, floating D-rings, double J-hooks
- 4536 kg maximum load, 1497 kg working load
- » 2884032



SHOCK STRAPS

- 3.8 cm 1361 kg breaking strength
- Keeps tension on tie-down straps to secure load, 2 Pack
- » 3.8 cm x 4.6 m • 2883296
- » 3.8 cm x 2.1 m • 2883295

COVERS



TRAILERABLE COVER BY POLARIS

- » 2-SEAT • 2881841
- POLARIS GENERAL XP 1000 '20-21
- POLARIS GENERAL 1000 '16-21
- » 4-SEAT • 2881787
- POLARIS GENERAL XP 4 1000 '20-21
- POLARIS GENERAL 4 1000 '17-21



POLARIS SxS CAMO FIELD COVER

- » 2882160
- POLARIS GENERAL XP 1000/4 '20-21
- POLARIS GENERAL 1000/4 '16-21

ELEVATE YOUR ADVENTURE



0% FINANCE



INTEREST-FREE FINANCE*

Included on all new Sportsman, Ranger, RZR, General and Scrambler models†.

ATVTRAC



QUICK AND SIMPLE OFF-ROAD SECURITY
ATVTrac is included with all our vehicles**, alongside a free 12 months subscription. Simply complete the online registration process and you'll be protected within minutes.

TWO YEAR WARRANTY



ULTIMATE PEACE OF MIND

All models come with a 2-year warranty as standard.

EASI

European ATV Safety Institute



GET FREE EASI TRAINING WORTH £180*
The European All-Terrain Vehicle Safety Institute provides free training courses for operators when they purchase a new POLARIS® ATV or SxS.

VISIT
POLARISBRITAIN.COM FOR MORE INFO

POLARIS

MY21 GENERAL APP ACC EMEA

* Subject to terms and conditions. † Excludes Youth.